

RESPIRATORY CATALOG

EVERYDAY AND SPECIALTY PRODUCTS

 <p>Pg 2-3 ... Suction Regulators</p>	 <p>Pg 4-7 Flowmeters</p>	 <p>Pg 8 Respirometers</p>	 <p>Pg 9..... Repairs</p>
 <p>Pg 10-12 Cylinder Carts</p>	 <p>Pg 13 Hose Assemblies</p>	 <p>Pg 14-17..... Regulators</p>	 <p>Pg 18,19..... Rail Systems</p>
 <p>Pg 20 Sensors</p>	 <p>Pg 21 .. Oximeters, Analyzers</p>	 <p>Pg 22 Compressors</p>	 <p>Pg 23 Peak Flowmeters</p>
 <p>Pg 24-26 . Hudson Disposables</p>	 <p>Quick Connects Pg 27-30 .. NPT, DISS Fittings</p>	 <p>Pg 31-35..... Miscellaneous</p>	 <p>Pg 36 Specials, Terms</p>



Online ordering available in 2014!



FAST DELIVERY

RC MEDICAL, INC.

Phone: 888-431-2727 • Fax: 888-337-0443

Visit us online at: www.rcmedical.com

2014

P.O. Box 833

• 284 Merrow Road •

Tolland, CT 06084

VACUTRON SUCTION REGULATORS by Allied

The new, sleekly contoured Vacutron[®] is a precision engineered instrument that combines the most desirable features for suction regulators. Smaller in size, but big on benefits, it offers advantages that include:

Slimmer line saves space, yet model is more durable than ever.

Color-coded glow-in-the-dark gauge face provides easy readability under any conditions. Gauge is secured by a screw for durability.

Weight-bearing brass post prevents case from cracking. Various inlet and outlet fittings insure compatibility with existing fixtures in any medical facility.

DISS fitting (can be ordered with a tubing nipple)



Easy access ON/OFF *Soft-Touch* knob gives full-line capability on the surgical model.

Maintenance is easy. Clean by flushing with cold sterilant.

0-200 mmHg is achieved easily with minimal turning of the knob. Vacuum-limiting valve on the continuous model limits vacuum at 300 mmHg to prevent potential tissue damage.

New larger *Soft-Touch* knob for quick, fumble-free action. Exposed bottom allows thumb-wheel adjustment. Oversized knob for easy operation.

Collection Canisters

Built-in tubing hooks eliminate the need to wrap excess tubing around regulator, preventing kinks and occlusions.

Unique DISS connection accessory allows canister to attach directly to most suction regulators.

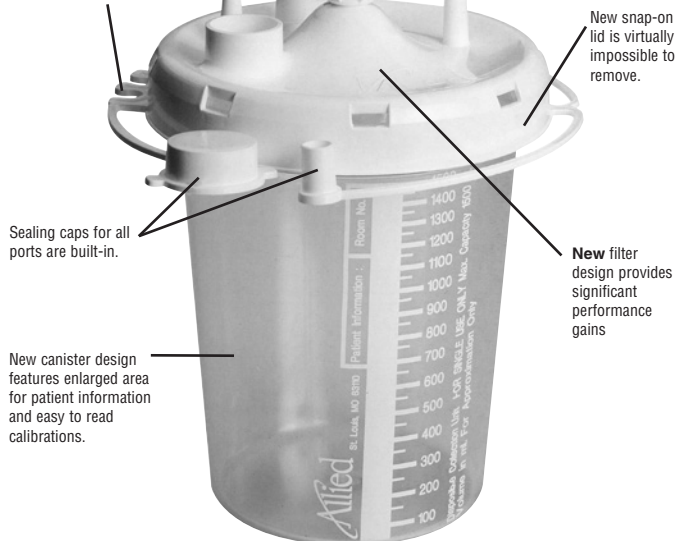

New snap-on lid is virtually impossible to remove.

Sealing caps for all ports are built-in.

New filter design provides significant performance gains

New canister design features enlarged area for patient information and easy to read calibrations.

Disposable Collection Canisters

Size	Outlet	Units/Case	Part Number	Price
2400ML	DISS	36/CASE	20-08-0001	\$244.00
2400ML	STEM	36/CASE	20-08-0002	237.00
1500ML	STEM	48/CASE	20-08-0003	256.00
1500ML	DISS	48/CASE	20-08-0004	263.00
2400ML	DISS	36/CASE w/tubing	20-08-0005	318.00
2400ML	STEM	36/CASE w/tubing	20-08-0006	337.00
1500ML	STEM	42/CASE w/tubing	20-08-0007	372.00
1500ML	DISS	42/CASE w/tubing	20-08-0008	359.00

Vac Trap



PM9003

The Vac Trap protects suction regulators and central vacuum systems from accidental contamination by liquid overflow from suction collection canisters.

This unique design assures positive shut-off at low as well as line vacuum conditions.

Price.....\$79.00



1/8" NPT Tubing Nipple #9073.....\$15.00



1/8" DISS Male Outlet #0751.....\$15.00

Continuous Suction Regulator

Part #	Inlet	Outlet	Price
22-13-1106	Ohmeda	DISS Male	\$499.00
22-13-1107	DISS Female	DISS Male	499.00
22-13-1108	Chematron (NCG)	DISS Male	499.00
22-13-1105	Puritan-Bennett	DISS Male	499.00
22-13-1206	Ohmeda	Tubing Nipple	499.00
22-13-1207	DISS Female	Tubing Nipple	499.00
22-13-1208	Chematron (NCG)	Tubing Nipple	499.00
22-13-1205	Puritan-Bennett	Tubing Nipple	499.00

Continuous/Intermittent Suction Regulator

22-15-1106	Ohmeda	DISS Male	\$899.00
22-15-1107	DISS Female	DISS Male	899.00
22-15-1108	Chematron (NCG)	DISS Male	899.00
22-15-1105	Puritan-Bennett	DISS Male	899.00
22-15-1206	Ohmeda	Tubing Nipple	899.00
22-15-1207	DISS Female	Tubing Nipple	899.00
22-15-1208	Chematron (NCG)	Tubing Nipple	899.00
22-15-1205	Puritan-Bennett	Tubing Nipple	899.00

EZ VAC ASPIRATOR – by Precision Medical



- Hydrophobic Filter Protection System
- Five (5) Year Warranty
- 1/5 Horsepower
- Hosp. grade plug
- 800CC and 1200CC Canisters
- Non-marring Suction Feet
- 120V/60 Hz motor
- 0-27" Hg Vacuum range

The EZ Vac portable aspirator can be used on crash carts and for wall suction backup.

PM60-3HG\$369.00

800 cc Canisters cs/10 #502519-10\$69.00

SUCTION REGULATORS – by Precision Medical CONTINUOUS AND CONTINUOUS/INTERMITTENT



PM3000
2 Mode - Continuous
\$279.00
(no adapters)



PM3100
3 Mode - Continuous
\$279.00
(no adapters)



PM3300
Continuous/Intermittent
\$557.00
(no adapters)

TO ORDER

Use the chart below to determine the inlet and outlet adapters you will need for your facility to obtain the proper part number.

ie: PM3005 - 2 mode regulator with Chemetron Quick Connect and tubing nipple.

Features:

- Compact and lightweight.
- Gauge is fully protected in case.
- Modular design for ease of maintenance.
- Large internal ports assure maximum flows.
- Solid cast metal backplate to ensure strength.
- Large regulator and mode selector knobs for easy adjustment.
- Designed for general patient use with vacuum regulation for 0-200 mm Hg.
- Color coded gauge indicates Low - Medium - High and Full vacuum conditions.

VACUUM SOURCE CONNECTION

	NO ADAPTER	DISS HEX	DISS H.T.	OHMEDA	CHEMETRON	OXEQUIP	PURITAN-BENNETT
PM3000 WITH TUBING NIPPLE	PM3001 302.00	PM3002 306.00	PM3003 308.00	PM3004 314.00	PM3005 314.00	PM3006 314.00	PM3008 311.00
PM3100 WITH TUBING NIPPLE	PM3101 302.00	PM3102 306.00	PM3103 308.00	PM3104 314.00	PM3105 314.00	PM3106 314.00	PM3108 311.00
PM3300 WITH TUBING NIPPLE	PM3301 578.00	PM3302 582.00	PM3303 584.00	PM3304 590.00	PM3305 590.00	PM3306 590.00	PM3308 587.00
PM3000 WITH DISS MALE	PM3012 302.00	PM3013 306.00	PM3014 308.00	PM3015 314.00	PM3016 314.00	PM3017 314.00	PM3019 311.00
PM3100 WITH DISS MALE	PM3112 302.00	PM3113 306.00	PM3114 308.00	PM3115 314.00	PM3116 314.00	PM3117 314.00	PM3119 311.00
PM3300 WITH DISS MALE	PM3312 578.00	PM3313 582.00	PM3314 584.00	PM3315 590.00	PM3316 590.00	PM3317 590.00	PM3319 587.00

Suction Canister Holder with Wall Bracket



Part Number 20-02-0150B
\$57.50

6' Lengths Clear Tubing



Part #	Price	Quantity
AV-2160TE	3.50	each
AV-2160T	89.50	case/50

2-1/2" Extension Adapter
to keep regulator away from wall to accommodate canisters



Part # MA-32..... \$18.50

Western Medica Suction Regulators

Adult Continuous

Suction 0-200 mmHg
0-80 LPM
SRQ2000 Suction Regulator
\$339.00



Adult Continuous/Intermittent

Suction Intermittent 0-Full Vacuum/0-200 LPM
SRQ2100 Suction Regulator w/Intermittent
\$539.00



Nursery

Nursery 0-100 mmHg
0-30 LPM
SRQ2200 Suction Regulator
\$419.00



Regulator Features

- Durable plastic case
- Accurate suction control within range
- Easy to use control knob
- Quick switch for REG/OFF/FULL VACUUM
- 2-1/2" diameter gauge
- Simplified internal mechanical design

	Continuous	Continuous/Intermittent	Nursery
Diss Female w/hand nut	SRQ-2004	SRQ-2104	SRQ-2204
Chemetron (NCG)	SRQ-2009	SRQ-2109	SRQ-2209
Ohio (Ohmeda)	SRQ-2007	SRQ-2107	SRQ-2207
Puritan	SRQ-2008	SRQ-2108	SRQ-2208
Oxequip	SRQ-2006	SRQ-2106	SRQ-2206
	\$349.00	549.00	419.00



Tubing Nipple

All regulators come with tubing nipple outlets. To order regulators with DISS male outlets, add a "D" to the end of the part number.



The price is the same.



DISS Male

Western Medica Suction Regulators

SPECIAL \$249.00 EACH



SR2104
Chrome Plated
Brass

Add a "T" to the end of part number for tubing nipple. The price is still \$249.00

Part # 9073
\$15.00

- On/Off control
- Chrome Plated Brass
- Adjustable, Lockable Suction Limit
- Simplified Internal Mechanical Design
- Infinite Suction Control Within Locked Range

Range Inlet Connections	0-200 mm Hg
DISS Handtight Nut and Nipple	SR2104
Ohmeda Adaptor	SR2107
Puritan Adaptor	SR2108
Chemetron Adaptor	SR2109
Oxequip Adaptor	SR2106

DISPOSABLE BACTERIAL FILTER PLUS

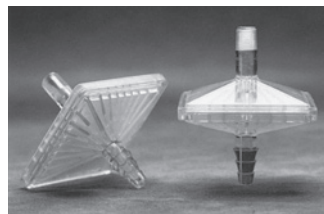

This disposable filter is designed to help protect the vacuum system from contamination due to aerosols or collection bottle overflow. This high efficiency bacteria filter features a hydrophobic, microporous membrane which filters air with maximum efficiency while helping to block the flow of aqueous fluids and aerosol contaminants.

Connection 1/4" hose barb x 1/4" hose barb, 3 filters/pkg.

Part # 22-95-1101 \$38.50

Connection 1/8" NPT x 1/4" hose barb, 3 filters/pkg.

Part # 22-95-1100 \$38.50

PRECISION MEDICAL COMPACT CHROME BODY FLOWMETERS



(8MFA1001)

15 LPM OXYGEN FLOWMETER WITH ADAPTER

Part #	Adapter	Price
8MFA1001	None - 1/8" NPT Female	\$36.00
8MFA1002	Diss Female	42.00
8MFA1003	Diss Female w/hand nut	43.00
8MFA1006	Chemetron (NCG)	67.00
8MFA1005	Ohio (Ohmeda)	67.00
8MFA1008	Puritan	45.00
8MFA1004	DISS Male	54.00
8MFA1007	Oxequip	52.00

15 LPM OXYGEN FLOWMETER WITH 50 PSI AUXILIARY VALVE AND ADAPTER

Part #	Adapter	Price
8MFA1001 PT0	None - 1/8" NPT Female	\$46.00
8MFA1002 PT0	Diss Female	51.00
8MFA1003 PT0	Diss Female w/hand nut	53.00
8MFA1006 PT0	Chemetron (NCG)	74.00
8MFA1005 PT0	Ohio (Ohmeda)	74.00
8MFA1008 PT0	Puritan	55.00
8MFA1004 PT0	DISS Male	63.00
8MFA1007 PT0	Oxequip	62.00

15 LPM AIR FLOWMETER WITH ADAPTER

Part #	Adapter	Price
8MFA2001	None - 1/8" NPT Female	\$36.00
8MFA2002	Diss Female	45.00
8MFA2003	Diss Female w/hand nut	50.00
8MFA2006	Chemetron (NCG)	70.00
8MFA2005	Ohio (Ohmeda)	70.00
8MFA2008	Puritan	49.00
8MFA2004	DISS Male	58.00
8MFA2007	Oxequip	54.00

15 LPM AIR FLOWMETER WITH 50 PSI AUXILIARY VALVE AND ADAPTER

Part #	Adapter	Price
8MFA2001 PT0	None - 1/8" NPT Female	\$50.00
8MFA2002 PT0	Diss Female	56.00
8MFA2003 PT0	Diss Female w/hand nut	63.00
8MFA2006 PT0	Chemetron (NCG)	78.00
8MFA2005 PT0	Ohio (Ohmeda)	78.00
8MFA2008 PT0	Puritan	63.00
8MFA2004 PT0	DISS Male	71.00
8MFA2007 PT0	Oxequip	68.00

15 LPM DUAL OXYGEN FLOWMETER WITH ADAPTER

Part #	Adapter	Price
Y8MFA1001	None - 1/8" NPT Female	\$83.00
Y8MFA1002	Diss Female	88.00
Y8MFA1003	Diss Female w/hand nut	90.00
Y8MFA1006	Chemetron (NCG)	113.00
Y8MFA1005	Ohio (Ohmeda)	112.00
Y8MFA1008	Puritan	87.00
Y8MFA1004	DISS Male	100.00
Y8MFA1007	Oxequip	98.00

15 LPM DUAL AIR FLOWMETER WITH ADAPTER

Part #	Adapter	Price
Y8MFA2001	None - 1/8" NPT Female	\$88.00
Y8MFA2002	Diss Female	93.00
Y8MFA2003	Diss Female w/hand nut	95.00
Y8MFA2006	Chemetron (NCG)	118.00
Y8MFA2005	Ohio (Ohmeda)	117.00
Y8MFA2008	Puritan	92.00
Y8MFA2004	DISS Male	105.00
Y8MFA2007	Oxequip	103.00

15 LPM DUAL OXYGEN FLOWMETER WITH (2) 50 PSI AUXILIARY VALVE AND ADAPTER

Part #	Adapter	Price
Y8MFA1001 PT2	None - 1/8" NPT Female	\$ 93.00
Y8MFA1002 PT2	Diss Female	98.00
Y8MFA1003 PT2	Diss Female w/hand nut	99.00
Y8MFA1006 PT2	Chemetron (NCG)	130.00
Y8MFA1005 PT2	Ohio (Ohmeda)	128.00
Y8MFA1008 PT2	Puritan	96.00
Y8MFA1004 PT2	DISS Male	109.00
Y8MFA1007 PT2	Oxequip	107.00

15 LPM DUAL AIR FLOWMETER WITH (2) 50 PSI AUXILIARY VALVE AND ADAPTER

Part #	Adapter	Price
Y8MFA2001 PT2	None - 1/8" NPT Female	\$ 98.00
Y8MFA2002 PT2	Diss Female	103.00
Y8MFA2003 PT2	Diss Female w/hand nut	104.00
Y8MFA2006 PT2	Chemetron (NCG)	135.00
Y8MFA2005 PT2	Ohio (Ohmeda)	133.00
Y8MFA2008 PT2	Puritan	101.00
Y8MFA2004 PT2	DISS Male	114.00
Y8MFA2007 PT2	Oxequip	112.00



(Y8MFA1006PT2)

CHAIN-RING ASSEMBLY



The Chain-Ring Assembly is used to permanently attach Flowmeters to the wall outlet.

Part #	Description	Price
8004	6" Chain w/Closed Ring	\$6.20
8005	6" Chain w/Open Ring	6.20

ADAPTERS

(see page 28 for pricing for adapters only)



Diss Female



Diss Female w/hand nut

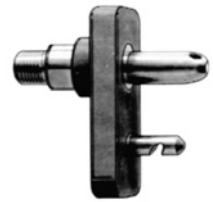

Chemetron (NCG)



Ohio (Ohmeda)

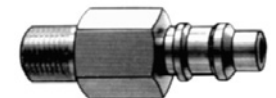

Puritan

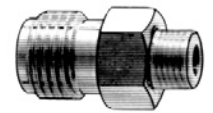

DISS Male



Oxequip



50 PSI Auxiliary Valve

OPTO - \$16.00 (oxygen)

APTO - \$19.00 (AIR)

Western Medica Chrome & Aluminum Body Flowmeter

6 Year
Warranty



(FMA104)

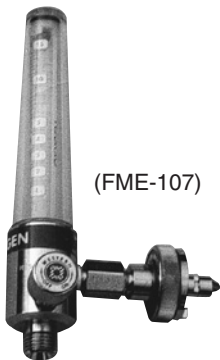

(FME-107)



(FME-109)



(FMA309)

1/4 - 3 1/2 LPM OXYGEN FLOWMETER WITH ADAPTER

ALUMINUM	CHROME	ADAPTER	PRICE
FMA901	FME901	None - 1/8" NPT Female	\$92.00
FMA903	FME903	DISS FEMALE	94.25
FMA904	FME904	DISS FEMALE w/hand nut	98.10
FMA909	FME909	CHEMETRON (NCG)	115.00
FMA907	FME907	OHIO	115.00
FMA908	FME908	PURITAN	98.10
FMA902	FME902	1/4" NPT MALE	91.00
FMA906	FME906	OXEQUIP	104.80

8 LPM OXYGEN FLOWMETER WITH ADAPTER

ALUMINUM	CHROME	ADAPTER	PRICE
Not Available in Aluminum	FM201	None - 1/8" NPT Female	\$70.00
	FM203	DISS FEMALE	77.00
	FM204	DISS FEMALE w/hand nut	78.50
	FM209	CHEMETRON (NCG)	96.20
	FM207	OHIO	97.40
	FM208	PURITAN	79.70
	FM202	1/4" NPT MALE	74.25
	FM206	OXEQUIP	83.80

15 LPM OXYGEN FLOWMETER WITH ADAPTER

ALUMINUM	CHROME	ADAPTER	PRICE
FMA101	FME101	None - 1/8" NPT Female	\$47.75
FMA103	FME103	DISS FEMALE	57.00
FMA104	FME104	DISS FEMALE w/hand nut	57.00
FMA109	FME109	CHEMETRON (NCG)	77.00
FMA107	FME107	OHIO	77.00
FMA108	FME108	PURITAN	58.20
FMA102	FME102	1/4" NPT MALE	47.50
FMA106	FME106	OXEQUIP	60.70

15 LPM OXYGEN FLOWMETER WITH 50 P.S.I. AUXILIARY VALVE AND ADAPTER

ALUMINUM	CHROME	ADAPTER	PRICE
FMA301	FME301	None - 1/8" NPT Female	\$76.50
FMA303	FME303	DISS FEMALE	85.75
FMA304	FME304	DISS FEMALE w/hand nut	89.90
FMA309	FME309	CHEMETRON (NCG)	103.00
FMA307	FME307	OHIO	103.00
FMA308	FME308	PURITAN	84.40
FMA302	FME302	1/4" NPT MALE	83.00
FMA306	FME306	OXEQUIP	96.45

15 LPM DUAL OXYGEN FLOWMETER WITH ADAPTER

ALUMINUM	CHROME	ADAPTER	PRICE
Not Available in Aluminum	FM401	None - 1/8" NPT Female	\$131.95
	FM403	DISS FEMALE	140.00
	FM404	DISS FEMALE w/hand nut	143.50
	FM409	CHEMETRON (NCG)	169.00
	FM407	OHIO	169.00
	FM408	PURITAN	141.40
	FM402	1/4" NPT MALE	137.50
	FM406	OXEQUIP	150.70

15 LPM AIR FLOWMETER WITH ADAPTER

ALUMINUM	CHROME	ADAPTER	PRICE
FMA601	FME601	None - 1/8" NPT Female	\$51.75
FMA604	FME604	DISS FEMALE	55.50
FMA609	FME609	CHEMETRON (NCG)	81.20
FMA607	FME607	OHIO	81.20
FMA608	FME608	PURITAN	74.00
FMA602	FME602	1/4" NPT MALE	51.50
FMA606	FME606	OXEQUIP	64.70

15 LPM AIR FLOWMETER WITH 50 P.S.I. AUXILIARY VALVE AND ADAPTER

ALUMINUM	CHROME	ADAPTER	PRICE
FMA701	FME701	None - 1/8" NPT Female	\$85.00
FMA703	FME703	DISS FEMALE	94.00
FMA709	FME709	CHEMETRON (NCG)	106.50
FMA707	FME707	OHIO	122.80
FMA708	FME708	PURITAN	95.70
FMA702	FME702	1/4" NPT MALE	88.50
FMA706	FME706	OXEQUIP	97.60
FMA704	FME704	DISS FEMALE w/hand nut	100.50

FLOW SELECTOR

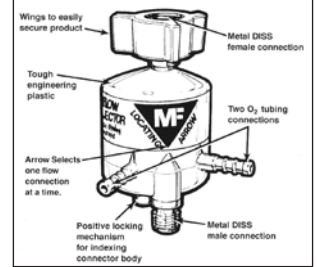

Flow Selector features:

- Give nebulizer treatments without disconnecting humidifier.
- Reduces changeover time to seconds.
- Humidifier, cannula and nebulizer hook-ups ready to go.
- No more loose tubing laying around.
- Eliminates tubing nipple adaptors (it has 2 of its own).
- Transforms flowmeter from single DISS male outlet to a multi-port device.
- Fits all flowmeters that have DISS male outlet fittings.
- Lightweight.

Part #1000.....\$39.00

CO₂ FLOWMETER

Part #	Adapter	Price
FME 801	None - 1/8" NPT Female	\$83.00
FME 802	1/4" NPT Male	87.00
FME 803	DISS Female	93.00



1/2 - 12 LPM

HELIOX FLOWMETER



0 - 15 LPM

FM16hf2 \$49.00

FIXED FLOW FLOWMETERS BY PRECISION MEDICAL (1/2 - 15LPM)

POLE CLAMP

Position Increments (LPM)
Off, .50, 1, 2, 3, 4, 5, 6, 8, 10, 15

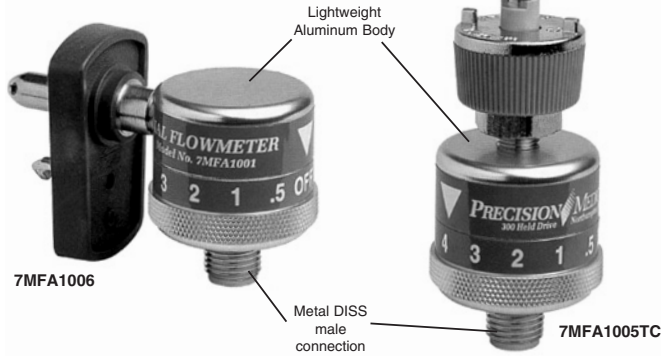

A NEW solution for an old problem

It's Durable
The lack of a flow tube and the durable metal body prevents breakage problems long associated with standard flowmeters.

It's Compact
The compact size allows the unit to fit into tight headwall areas and makes it virtually damage proof when other equipment is installed.

It's Accurate
The patented multi-spring technology insures accuracy at every flow setting without the need for a visible float as in thorpe tube flowmeters

It's User-Friendly
The knurled flow adjustment knob and the large, easy-to-read numbers make flow adjustment easy.

It's Versatile
The unit is available for headwall outlets as well as for ceiling mount drops. It comes in 2 different flow rates: .5 - 15/Flush and 1 - 25 lpm. Both air and oxygen models are available.

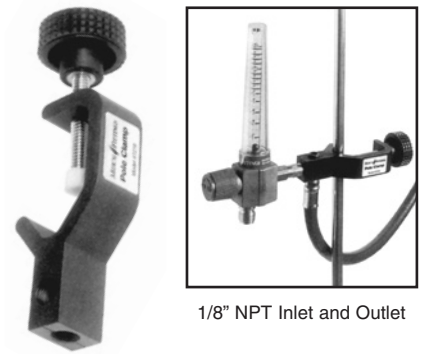

1/8" NPT Inlet and Outlet

Part #	For Use With	Price
7216	1" Pole	\$58.00
7227	1 1/2" Pole	58.00

Adapters	O2 With Adapter	Air With Adapter	O2 With Adapter & Aux. Valve	Air With Adapter & Aux. Valve
1/8" NPT FE	7MFA1001 \$56.95	7MFA2001 \$56.95	7MFA1001PTO \$56.95	7MFA2001PTO \$68.95
DISS Female Hex Nut	7MFA1002 \$60.60	7MFA2002 \$61.25	7MFA1002PTO \$70.60	7MFA2002PTO \$73.25
DISS Female Hand Tight	7MFA1003 \$62.75	7MFA2003 \$63.75	7MFA1003PTO \$72.75	7MFA2003PTO \$75.75
Ohmeda	7MFA1005 \$81.10	7MFA2005 \$83.00	7MFA1005PTO \$91.10	7MFA2005PTO \$95.00
Chemetron (NCG)	7MFA1006 \$79.50	7MFA2006 \$81.00	7MFA1006PTO \$89.50	7MFA2006PTO \$93.00
Oxequip	7MFA1007 \$78.00	7MFA2007 \$79.50	7MFA1007PTO \$88.00	7MFA2007PTO \$91.50
Puritan-Bennett	7MFA1008 \$75.50	7MFA2008 \$76.70	7MFA1008PTO \$85.50	7MFA2008PTO \$88.70

For Connection On Top, Add **TC** To End Of Part Number (ie: 7MFA1001**TC**)

TIMETER CLASSIC™ OXYGEN FLOWMETERS



0-16 LPM

Part #	Adapter	Price
B10	None -1/8" NPT Female	\$144.00
TZ06-B10	DISS Female	156.00
TZ12-B10	DISS Female w/hand nut	163.00
TZ03-B10	Chemetron NCG	168.00
TZ04-B10	Ohmeda	168.00
TZ02-B10	Puritan	154.00
TZ05-B10	Schrader	156.00
TZ01-B10	Oxequip	163.00

Features a square body.

15 Lpm Flowmeter for Chemetron wall outlet with 50 psi Chemetron female quick connect

Gas	Part #	Price
Oxygen	FME 409-CHF	\$217.50
Air	FME 609-CHF	\$223.00



15 Lpm Flowmeter for Ohmeda wall outlet with 50 psi Ohmeda female quick connect

Gas	Part #	Price
Oxygen	FME 407-OHF	\$220.50
Air	FME 607-OHF	\$226.00



15 LPM Flowmeter for Chemetron Wall Outlet with 50 psi Chemetron Female Quick Connect



Oxygen
8MFA1006CHF
\$169.00

Air
8MFA2006CHF
\$169.00

15 LPM Flowmeter for Ohmeda Wall Outlet with 50 psi Ohmeda Female Quick Connect



Oxygen
8MFA1005OHF1
\$169.00

Air
8MFA2005OHF1
\$169.00

PRECISION MEDICAL SELECT FLOWMETER

The Select Flowmeter combines the quality, accuracy and durability of the Precision Medical Aluminum Body Flowmeter with the unique features of the Flow Selector. The result is an exceptional hybrid, the Select Flowmeter.



15 LPM OXYGEN FLOWMETER WITH ADAPTER

Part #	Adapter	Price
3MFA1001	None - 1/8" NPT Female	\$74.00
3MFA1002	Diss Female	80.00
3MFA1003	Diss Female w/ hand nut	82.00
3MFA1006	Chemetron (NCG)	92.00
3MFA1005	Ohio (Ohmeda)	94.00
3MFA1008	Puritan	86.00
3MFA1009	Schrader	94.00
3MFA1007	Oxequip	92.00

15 LPM OXYGEN FLOWMETER WITH 50 PSI AUXILIARY VALVE AND ADAPTER

Part #	Adapter	Price
3MFA1001 PT1	None - 1/8" NPT Female	\$84.00
3MFA1002 PT1	Diss Female	89.00
3MFA1003 PT1	Diss Female w/ hand nut	91.00
3MFA1006 PT1	Chemetron (NCG)	102.00
3MFA1005 PT1	Ohio (Ohmeda)	103.00
3MFA1008 PT1	Puritan	95.00
3MFA1009 PT1	Schrader	104.00
3MFA1007 PT1	Oxequip	102.00

15 LPM DUAL OXYGEN FLOWMETER WITH ADAPTER

Part #	Adapter	Price
Y3MFA1001	None - 1/8" NPT Female	\$144.00
Y3MFA1002	Diss Female	150.00
Y3MFA1003	Diss Female w/ hand nut	152.00
Y3MFA1006	Chemetron (NCG)	162.00
Y3MFA1005	Ohio (Ohmeda)	164.00
Y3MFA1008	Puritan	156.00
Y3MFA1009	Schrader	164.00
Y3MFA1007	Oxequip	162.00

Flow Selector - Page 5

More Flowmeters on Page 21

HIGH FLOW FLOWMETERS

0-70 LPM BY PRECISION MEDICAL WITH ADAPTER

OXYGEN

Part #	Adapter	Price
1MFA8001	None - 1/8" NPT Female	\$100.00
1MFA8002	Diss Female	105.00
1MFA8003	Diss Female w/ hand nut	106.00
1MFA8006	Chemetron (NCG)	118.00
1MFA8005	Ohio (Ohmeda)	119.00
1MFA8008	Puritan	111.00
1MFA8009	Schrader	120.00
1MFA8007	Oxequip	118.00

AIR

Part #	Adapter	Price
1MFA9001	None - 1/8" NPT Female	\$100.00
1MFA9002	Diss Female	110.00
1MFA9003	Diss Female w/ hand nut	113.00
1MFA9006	Chemetron (NCG)	118.00
1MFA9005	Ohio (Ohmeda)	120.00
1MFA9008	Puritan	114.00
1MFA9009	Schrader	123.00
1MFA9007	Oxequip	120.00



FLOWMETER REPAIR KITS



15 LPM

Description	Part Number	Price
Precision Chrome Body	RK1120	\$63.00
Precision Select	RK3120	76.00
Western Medica	RK1005	98.50

HOSPITAL PIPING SYSTEM TEST GAUGE



0-100 PSI Test Gauge

7340 0-100 PSI Test Gauge x O ₂ Diss HT	79.00
7341 0-100 PSI Test Gauge x O ₂ Ohmeda	90.00
7342 0-100 PSI Test Gauge x O ₂ Chemetron	88.00
7343 0-100 PSI Test Gauge x O ₂ Puritan	80.00
7344 0-100 PSI Test Gauge x O ₂ Oxequip	84.00
7345 0-100 PSI Test Gauge x O ₂ Schrader	88.00
7350 0-100 PSI Test Gauge x Air Diss HT	83.00
7351 0-100 PSI Test Gauge x Air Ohmeda	85.00
7352 0-100 PSI Test Gauge x Air Chemetron	89.00
7353 0-100 PSI Test Gauge x Air Puritan	83.00
7354 0-100 PSI Test Gauge x Air Oxequip	88.00
7355 0-100 PSI Test Gauge x Air Schrader	92.00

FLO-LOK FLOWMETER

Precision Medical "TAMPER PROOF" with adapter

Part #	Adapter	Price
1MFA1991	None - 1/8" NPT Female	\$83.00
1MFA1992	Diss Female	88.00
1MFA1993	Diss Female w/hand nut	90.00
1MFA1996	Chemetron (NCG)	101.00
1MFA1995	Ohio (Ohmeda)	102.00
1MFA1998	Puritan	94.00
1MFA1999	Schrader	103.00
1MFA1997	Oxequip	101.00



flow can be set from 0-15 then locked in so patients cannot adjust

RESPIROMETERS

(RUBBER PROTECTORS ON NEXT PAGE)

MARK 8



1.4" Face

For measurement of minute volumes as well as tidal volumes. Two dials. Small dial records 0-1 liter. Large dial 0-100 liters.

Used Respirometers

Fully Serviced, Cleaned, Oiled and Calibrated

1 Year Warranty

Order #2799\$995
(Free Spiro-guard and case)

MARK 14



1.4" Face

Specially suited for the measurement of tidal volumes and may also be used for measurement of minute volumes. Two dials. Small dial records 0-10 liters. Large dial records 0-1 liter.

HALOSCALE STANDARD



2.25" Face

The original design of Haloscale Respirometer incorporating concentric dials and an enlarged face for improved readability. Equally convenient for measuring both tidal and minute volumes. Large 57 mm dial diameter. Red/black hands and black scales on a white background with yellow highlight ring. Two concentric outer dials. First dial records 0-1 liter. Second dial records 0-100 liters.

ORDER #	RESPIROMETERS DESCRIPTION	PRICE
2750.....	Mark 8 Respirometer.....	\$1565.00
2751.....	Mark 14 Respirometer.....	1565.00
2768.....	Haloscale Standard.....	1615.00

RESPIROMETERS WITH SPIRO GUARD

2756.....	Mark 8 Respirometer.....	1629.00
2757.....	Mark 14 Respirometer.....	1629.00
2769.....	Haloscale Standard.....	1679.00

RESPIROMETERS WITH SPIRO GUARD AND EXTRA LARGE CARRYING CASE

2762.....	Mark 8 Respirometer.....	1659.00
2763.....	Mark 14 Respirometer.....	1659.00
2772.....	Haloscale Standard.....	1709.00

All respirometers come with a standard zippered carrying case, two metal adapters, and harness. Spiro-Guards and extra large carrying cases are optional.

RC MEDICAL WILL EXTEND THE WARRANTY FROM ONE YEAR TO TWO YEARS ON ANY NEW RESPIROMETER PURCHASED FROM US!

MARK 20

Discontinued Model
NEW!
FREE Spiro-Guard case and adapters

ELECTRONIC DIGITAL RESPIROMETER



ANESTHESIA ASSOCIATES



Shown separated with optional cable # 296

A respirometer long overdue in this modern electronic age

MODEL 295 DIGITAL RESPIROMETER IS AN ELECTRONIC VERSION OF THE MECHANICAL RESPIROMETER.

IT DOES THE SAME JOB PLUS

- Easier to read
- Saving on the initial purchase and maintenance
- More reliable
- Extremely durable
- No gears, shafts, or bearings to break down in the electronic unit
- Separates for ease of patient use, sterilization and cleaning
- Made in U.S.A.

WARRANTY

All Electronic Respirometers are warranted for one year from date of purchase for defects in material and workmanship. Only factory trained and authorized repair centers should be utilized.

Part #		Price
295	Respirometer	\$940.00
Options		
296	6' Retractable Cable (extended length)	\$144.00
298	Carrying Case	88.00
299	Spare Flow Sensing Unit	395.00

Model 295, a two piece detachable respirometer comes complete ready to use with 9v battery and one (1) 22 mm female x 22 mm female adapter.



2.25" Face

Same as Mark 8 but has concentric dials and enlarged face for improved readability. Two concentric dials. White dial reads 0-1 liter. Yellow dial records 0-100 liters.

Part # 2758.. \$1295.00

RESPIROMETER ADAPTERS

2700-30 Soft Plastic Adapter



\$24.00

22 - 23mm x 22 - 23mm

will accommodate 22mm or 23mm outlets (all respirometer inlets except Infanta)

2700-31 Silicone Adapter



\$24.00

24mm x 15mm

Stainless Steel

106-S7	Adapter-22mm Female x Catheter	\$78.00
106-8*	Adapter-22mm Female x 22mm Female	\$89.25
106-9*	Adapter-22mm Female x 22mm Male/15mm Female	\$89.25

*comes standard with the purchase of any respirometer

RUBBER RESPIROMETER PROTECTORS

2700 Spiro-Guard



2701 Spiro-Guard



2702 Spiro-Guard



3000 Bo-Re-Gard

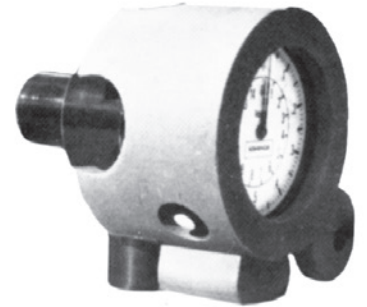

The Spiro-Guard was designed to help eliminate accidental damage to mechanical respirometers that can occur in the hurried environment of intensive care. This 1/4" shock absorbing rubber is very effective and will help keep your respirometers "In Service" rather than "Out Of Service". The Spiro-Guard does NOT have to be removed for any method of sterilization.

- 2700 Designed to fit: mark 8, mark 14, mark 25, physiological, haloscale compact, wright, penlon.....\$79.50
- 2701 Designed to fit: All Fraser-Harlake models OHMEDA (3 buttons)79.50
- 2702 Designed to fit: mark 12, mark 20, haloscale standard, wright.....79.50
- 3000 Designed to fit: All Boehringer Spirometers79.50

CARRYING CASES

2703 Carrying Case\$67.00



The 2703 carrying case was specifically designed EXTRA LARGE for the purpose of holding respirometers with Spiro-Guards on them. The plastic case does NOT have a zipper and is light-weight and durable.

(Respirometers, Spiro-Guards, and adapters not included.) 9" x 5" with carrying handle

Replacement Standard Zippered Carrying Case

#108517.....\$79.00



REPAIRS

Respirometers - \$169.00 includes cleaning, calibration and oiling. Parts are extra.

It is not necessary to obtain an RGA to send in repairs.

Please send them to the address below. Most repairs are returned to you in 5 days.

RC Medical Inc.
284 Merrow Road
Tolland, CT 06084

In our 17 years of respirometer repairing, these are the most common problems, in addition to our recommended yearly cleaning:

- Lens Cover cracked or missing
- Vane bent or blown out
- Rust

Most repairs are \$169 - \$200

All Models repaired including:

Wright • Ferraris
Haloscale
BOC
Fraser - Harlake
Ohmeda

**WE WILL GIVE YOU UP TO \$400.00
 IN FREE GOODS, FOR EVERY RESPIROMETER
 YOU SEND IN FOR TRADE.**



SMALL (D & E) CYLINDER CARTS, STANDS AND HOLDER

#6105.....\$48.70

41" high

Nonslip Ribbed Hand Grip

Gurney/ Mask Hook

Front Carrying Handle

Non-marring Thumb Screw

#PX-1020.....\$44.00

OUR BEST SELLING CART

Adjustable height small cylinder cart for "D" and "E" cylinders.

#6103-4.....\$173.00

Dual Tank
6203-4.....\$185.00

41" high
3" casters swivel w/brake

These four-wheeled units offer better control and easy maneuverability in and out of tight spaces. They require no tilting or balancing, giving you total control over the cylinder load.

#6106-CH
\$79.00

Cane Handle

41" high

#13001-2
\$96.00

Dual Tank

Adjustable height

Multiple (D & E) Small Cylinder Carts

HUDSON



Part # 1060F
Holds 4
Price \$108.00



1070F
6
118.00



1070T
6
138.00



1074F
9
152.00

No. 4012 Cylinder Holder \$89.00
Designed for the safe placement of oxygen cylinders on wheelchairs allowing for easy patient transport. Installation requires no tools or assembly. Constructed of lightweight, chromed tubular steel. D or E size cylinder can be secured by hand-tightening screw. Wheelchair can be folded without removing cylinder or holder.



No. 4009 Cylinder Holder \$77.00
Cylinder holder designed to slip easily over headboard, bedside rails or crash carts. Made of lightweight, chromed tubular steel. D or E size cylinder is secured in place by hand-tightening screw. No assembly required.



MODEL #610WM is a D or E size cylinder wall bracket that can be mounted to any solid surface or crash cart.... \$64.20



MODEL #610H is a D or E size cylinder stand designed to stand alone, be hand carried, laid down or hung on a gurney or wall for emergency applications...\$76.00

Fiberglass Cylinder Bases

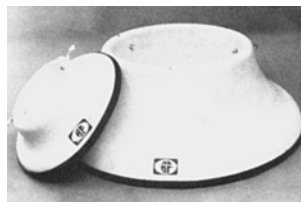

65040	For small 'D' or 'E' cylinder	\$39.00
HS-2	For large 'H' cylinder	\$69.00

MRI COMPATIBLE EQUIPMENT



D & E Cylinder Bracket
Part # 610WM-MRI..... \$110.00



Dual Tank
Part # 620WM-MRI..... \$180.00



D & E Cylinder Cart
Part # 6105-MRI..... \$215.00



Dual Tank
Part # 6205-MRI..... \$245.00

MULTIPLE D & E SIZE CYLINDER CARTS AND STANDS

2-Wheel Cart



Part #	Cylinders Held	Price	Dimensions (Height-Depth-Width)
6041	4	171.00	42" - 10" - 18"
6061	6	179.00	42" - 15" - 18"
6121	12	193.00	42" - 20" - 22"
With Sound Deadening Kit (below)			
6041-SDK	4	204.00	42" - 10" - 18"
6061-SDK	6	223.00	42" - 15" - 18"
6121-SDK	12	237.00	42" - 20" - 22"

4-Wheel Cart



Part #	Cylinders Held	Price	Dimensions (Height-Depth-Width)
6064	6	244.00	42" - 15" - 18"
6124	12	264.00	42" - 20" - 22"
6184*	18	272.00	42" - 30" - 16"
6244*	24	293.00	42" - 30" - 20"
With Sound Deadening Kit (below)			
6124-SDK	12	301.00	42" - 20" - 22"
6184-SDK*	18	313.00	42" - 30" - 16"
6244-SDK*	24	369.00	42" - 30" - 20"

* 4 - 4" Wheels

Multiple D & E Size Cylinder Stands



Part #	Cylinders Held	Price	Dimensions (Height-Depth-Width)
6040	4	133.00	20" - 13" - 11"
6060	6	143.00	20" - 12" - 15"
6120	12	153.00	20" - 15" - 22"
6180	18	170.00	20" - 15" - 32"
6240	24	185.00	20" - 20" - 32"
6400	40	305.00	20" - 40" - 25"

With Sound Deadening Kit (below)

6040-SDK	4	162.00	20" - 13" - 11"
6060-SDK	6	177.00	20" - 12" - 15"
6120-SDK	12	191.00	20" - 15" - 22"
6180-SDK	18	222.00	20" - 15" - 32"
6240-SDK	24	254.00	20" - 20" - 32"
6400-SDK	40	411.00	20" - 40" - 25"

Can be bolted to floor or free standing.

Multiple D & E Size Cylinder Stands With Wheels



Part #	Cylinders Held	Price	Dimensions (H.-D.-W.)
6040-PC	4	154.00	23"-13"-10"
6060-PC	6	171.00	23"-12"-15"
6120-PC	12	188.00	23"-15"-22"
With Sound Deadening Kit (below)			
6040-PC-SDK	4	183.00	23"-13"-11"
6060-PC-SDK	6	200.00	23"-12"-15"
6120-PC-SDK	12	213.00	23"-15"-22"

SOUND DEADENING KITS (for Carts Above)

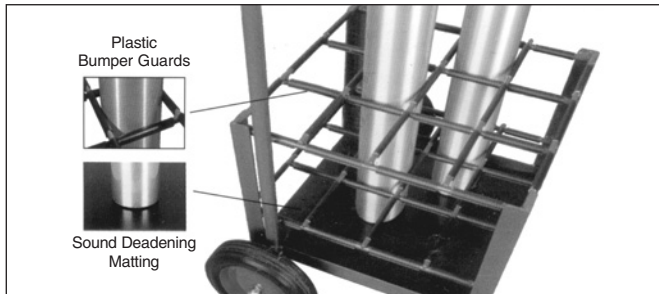

Anthony has developed an exclusive sound deadening system for their multiple cylinder carts, used to distribute cylinders in and around hospitals, rest homes, convalescent homes, etc. or where QUIET is essential.

These sound deadening kits include heavy-duty sound deadening matting and plastic bumper guards. This formula eliminates the rattling & clanging of steel & aluminum cylinders while in transport.

SOUND DEADENING KIT PART NO.	FIT ANTHONY MODELS	CYLINDER CAPACITY	PRICE
SDK-4E	6041	4	38.00
SDK-6E	6061	6	44.00
SDK-12E	6121, 6124	12	59.00
SDK-18E	6184	18	73.00
SDK-24E	6244	24	87.00

Layered D & E type cylinder carts and racks designed for easy storing of full and empty cylinders in the same unit. Constructed of heavy gauge square tubing, round bar, large 4" swivel casters w/ locks, and convenient full length push handles. These specially designed shelves are dirt and dust collection free and when moisture is present these shelves allow for free air flow drying.

LAYERED RACKS



LAYERED CARTS



For D&E Cylinders Only

Part #	Cylinders Held	Price	Dimensions (Height-Depth-Width)
LC25-4	25 (cart)	690.00	39" - 26" - 27"
LC50-4	50 (cart)	1290.00	73" - 26" - 27"
LR25	25 (rack)	660.00	34" - 26" - 27"
LR50	50 (rack)	1260.00	68" - 26" - 27"

Other sizes? Please call!

MULTIPLE CYLINDER STANDS Chrome

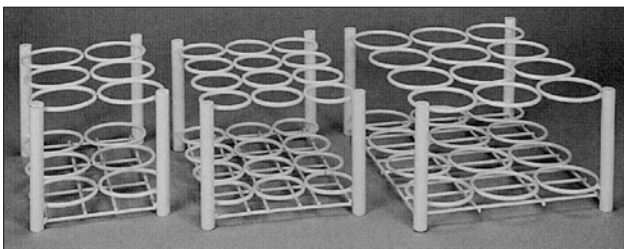

PX-1025

PX-1029

PX-1027

PX-1025	"D/E" Rack / 6 cylinders	9" x 15" x 10"	\$ 93.00
PX-1027	"D/E" Rack / 12 cylinders	9" x 15" x 20"	145.00
PX-1029	"M6" Rack / 12 cylinders	9" x 13" x 17"	123.00

Bolts to floor or free standing.

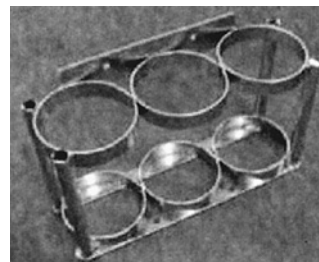

Holds 3 D or E size cylinders.
Mounts to wall or truck

Part # 7503F\$94.00

LARGE CYLINDER CARTS

Dual
6214



Single
6114



All models have 4 wheels.

Part #	Description	Rear Wheel Assembly	Price
6114	Single (Most Popular)	Retractable	\$257.00
6114R	Single	Stationary	253.00
6114-PN	Single-Pneumatic Wheels	Retractable	304.00
6114R-PN	Single-Pneumatic Wheels	Stationary	299.00
6114R-CRU	Single-Chrome	Stationary	295.00
6214	Dual	Retractable	325.00
6214-PN	Dual-Pneumatic Wheels	Retractable	370.00

Retractable Third Wheel



Part # HCC3-M
\$257.00

2 Wheels Only



Part # HCC2-M
\$169.00

LOCKING MODULAR CYLINDER RACKS

Built with the same heavy-duty construction as the modular racks on page 15, these units are equipped with hinged lockable front gates and stationary top plates to help prevent theft, misuse or mixing of high pressure cylinders while in storage. For large cylinders.

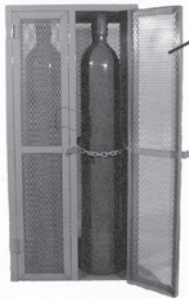

HEAVY GAUGE EXPANDED METAL ON ALL 4 SIDES



Larger MCR Units Not Shown

MCR-600-LFT\$942.00
Height: 64" Depth: 30"
Width: 28.5" Weight: 152 lbs
Cylinder Capacity: 6

MCR-800-LFT\$989.00
Height: 64" Depth: 40"
Width: 28.5" Weight: 192 lbs
Cylinder Capacity: 8

MCR-400-LFT\$894.00
Height: 64" Depth: 20"
Width: 28.5" Weight: 135 lbs
Cylinder Capacity: 4

DUAL CYLINDER STANDS



CH-200-C.....\$114.00
Height: 48" Depth: 10" (O.D.)
Width: 24" (O.D.) Weight: 22 lbs.
Dual Cylinders



BOLT DOWN ANGLE BRACKETS. (NOT FOR VEHICLE USE)

MODIFIED ITEMS AVAILABLE UPON REQUEST - CONTACT OUR OFFICE FOR DETAILS

The 610FW-E and 610FW-H are newly modified (by popular demand) with removable heavy-duty 3' x 1.50" rubber tired (125 lb. ea. L/R) casters for easier rolling over carpets and in and out of elevators.

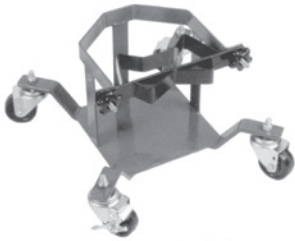

610FW-E.....\$179

Height: 12" Depth: 18" (O.D.)
Width: 18" (O.D.) Weight 24 lbs.



These models are equipped with heavy-duty 3' x 1.50" removable casters w/brakes



610FW-H.....\$192

Height: 48" Depth: 18" (O.D.)
Width: 18" (O.D.) Weight 25 lbs.

LARGE MULTIPLE CYLINDER STANDS

These modular cylinder racks are ruggedly constructed and have been designed to be anchored to the floor or bolted together expanding your cylinder storage needs. Constructed of heavy gauge 1 1/2" square tubing, 12 gauge steel floor plate and heavy duty safety chain to secure each cylinder individually with spring loaded safety latches.

Heavy Duty

SAFETY

- Complies with all seismic zone 4 regulations in the uniform building code (UBC)
- Meets or exceeds OSHA requirements

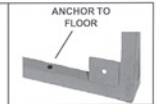
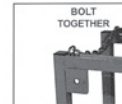

No. MCR-400 (Holds 4)
420.00



No. MCR-600 (Holds 6)
492.00



No. MCR-800 (Holds 8)
574.00

THIS PATENTED STAND HOLDS A 7" TO 9 1/2" CYLINDER.



610F-E.....\$93

Height: 12" Depth: 18" (O.D.)
Width: 18" (O.D.) Weight 14 lbs.

Fiberglass Cylinder Bases

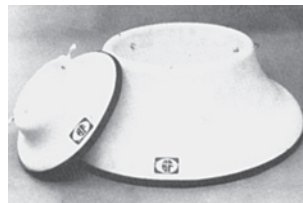

65040	For small 'D' or 'E' cylinder	\$39.00
HS-2	For large 'H' cylinder	\$69.00

M60 / M / H Cylinder Stand



Part # HCS2-M
\$79.00

CUSTOM HOSE ASSEMBLIES

REINFORCED MEDICAL HOSE

Ordering is easy as 1, 2, 3 . . . 4

How to Order:

Western medica manufactures custom hose assemblies that conform to CGS, and NFPA standards. All assemblies are pressure-tested. Select your requirement from the charts below.

Example: OXY-024-FNN-OHF

- 1) OXY Oxygen Service
- 2) 024 24" Long
- 3) FNN Inlet Connection
- 4) OHF Outlet Connection

Evacuation Hose (purple) price may be more, depending on your adaptor

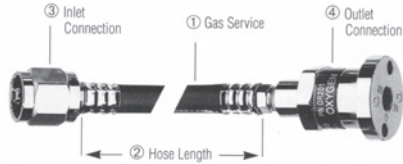

(Pricing for the above example)

FNN	17.00
OHF	69.00
Hose (.35 per inch x 24")	8.40
Assembly Charge	12.00
Total	\$106.40

Gas Service

OXY	Oxygen	Green
AIR	Medical Air	Yellow
SUC	Suction	White
N2O	Nitrous Oxide	Blue
EVC	Evacuation	Purple
CO ₂	Carbon Dioxide	Gray
NIT	Nitrogen	Black
GNR	General	Clear

Adapters pictured below may be ordered Separately.

When ordering adapters only, please specify gas.

Example: chm - oxy

All hose assemblies are 1/4" conductive (unless specified)

<p>#CHM \$37.60 Chemetron (NCG) Male</p>	<p>#FNN \$17.00 Diss Female with Hex nut</p>	<p>#FHT \$19.00 Diss Female with Hand Nut</p>	<p>#OHM \$38.20 Ohmeda Male</p>
<p>#MBA \$19.00 Diss Male</p>	<p>#SHM \$21.00 Schrader Male</p>	<p>#OXM \$23.50 Oxequip Male</p>	<p>#PBM \$23.50 Puritan - Bennett Male</p>
<p>#CHF \$67.00 Chemetron (NCG) Female</p>	<p>#SHF \$87.00 Schrader Female</p>	<p>#PBF \$61.00 Puritan - Bennett Female</p>	<p>#OHF \$69.00 Ohmeda Female</p>
<p>#DBA \$20.00 Demand Body Adaptor</p>	<p>#MP2 \$5.00 Male Pipe 1/8"</p>	<p>#MP4 \$5.00 Male Pipe 1/4"</p>	
<p>#FP2 \$5.00 Female Pipe 1/8"</p>	<p>#FP4 \$5.00 Female Pipe 1/4"</p>	<p>#BLK \$0.00 Blank (No Connection)</p>	



Hose only!

\$4.20 per foot

Conductive, Non-UL Listed
400 psi Working Pressure
1500 psi Burst Pressure

- MH4-04C.....1/4" ID, Nitrous Oxide (Blue)
- MH4-08C.....1/4" ID, Carbon Dioxide (Grey)
- MH4-12C.....1/4" ID, Nitrogen (Black)
- MH4-16C.....1/4" ID, Medical Air (Yellow)
- MH4-22C.....1/4" ID, Suction (White)
- MH4-24C.....1/4" ID, Oxygen (Green)
- MH5-22C.....5/16" ID, Suction (White)

HOSE REPAIR KIT



order part # MK-4\$307.00

Kit contains:

- Vice Grip Crimper
- Nipples w/hose barb
- Body Adapters & More
- O-rings
- Ferrules

HOSE SPLICER

For 1/4" ID Hose



MH-1.....\$3.00

FERRULE



For 1/4" hose
.525 ID

#M-625-A.....\$.70

VICE-GRIPS

For 3/16", 1/4" and
5/16" ID Hose

C-5A
\$59.00



Bench Top Crimper

CR-100 \$273.60

Bench Top Crimper for 3/16", 1/4", 5/16", and 3/8" ID Hose

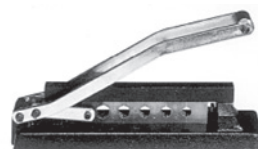

Western Medica OPA Series Compact Click-Style Regulators

Regulator Features

- Compact Aluminum body with brass inlet chamber
- Tested to CGA Standards which include ignition testing
- Dial-in flow control
- Maximum inlet pressure 3000 psi
- Sintered filter for safety and to extend regulator life
- Internal reseating relief valve protects against overpressurization
- 1 1/2" diameter gauge
- Hose barb outlet
- OPA series designed for pediatric, homecare, hospital and emergency applications
- 2-year limited warranty
- Free rubber gauge protector



OPA-820
Compact Click-Style Regulator
with CGA-870 Yoke inlet

\$89.00
12 or more
\$83.00

Compact OPA Models

Lpm	Model	Flow Settings	Cylinder Size	CGA
	OPA-510	1/64, 1/32, 1/16, 1/8, 1/4, 1/2, 3/4, 1, 1-1/2, 2 LPM	Large H K M	540
15	OPA-520	1/4, 1/2, 1, 2, 3, 4, 6, 8, 10, 15 LPM	Large H K M	540
	OPA-810	1/64, 1/32, 1/16, 1/8, 1/4, 1/2, 3/4, 1, 1-1/2, 2 LPM	Small D E	870
15	OPA-820	1/4, 1/2, 1, 2, 3, 4, 6, 8, 10, 15 LPM	Small D E	870
	OPA-840	1/2, 1, 2, 3, 4, 5, 6, 7, 8 LPM	Small D E	870

Precision "Easy Reg" 15 LPM

Lightweight
Only 7.8 oz.

Easy to tighten.



Part number 168715D \$79.00

ALLIED ALL BRASS OXYGEN REGULATORS

0, .5, 1, 1.5, 2, 3, 4, 5, 6, 8, 10, 15 settings

Order #21017 \$109.00
for small cylinder (870)



Nipple outlet not for
use with humidifier.



.5 - 15 LPM
Part # 21012 \$149.00

1 - 25 LPM
Part # 21025 \$149.00

Two high pressure
outlets also.



Drive Medical Fixed Flow E Cylinder Oxygen Regulator (Green)

Liter Flow Increments

0, .12, .5, 1, 1.5, 2, 3, 4, 6, 8, 10, 15

\$39.00

Part Number 18302GM



UL Approved

HIGH PRESSURE REGULATORS

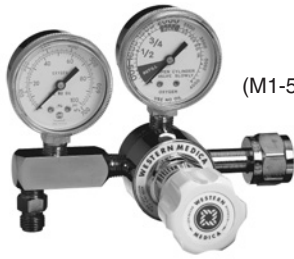

(M1-540 PG)

Adjustable 0 - 100 psi with DISS Outlet



Preset 50 psi with DISS Outlet



Preset 50 psi with DISS Outlet

Gas	Part #	Cylinder Size	Price
Oxy.	MI 540 PG	CGA 540 (Large)	\$144.00
Oxy.	MI 870 PG	CGA 870 (Small)	\$154.00
Air	MI 346 PG	CGA 346 (Large)	\$184.00
Air	MI 950 PG	CGA 950 (Small)	\$189.00

Gas	Part #	Cylinder Size	Price
Oxy.	MI 540 P	CGA 540 (Large)	\$129.00
Air	MI 346 P	CGA 346 (Large)	\$168.00
N ₂ O	MI 326 P	CGA 326 (Large)	\$154.00
CO ₂	MI 320 P	CGA 320 (Large)	\$160.00

Gas	Part #	Cylinder Size	Price
Oxy.	MR 870 P	CGA 870 (Small D&E)	\$131.00
Air	MI 950 P	CGA 950 (Small D&E)	\$173.00
N ₂ O	MI 910 P	CGA 910 (Small D&E)	\$158.00
CO ₂	MI 940 P	CGA 940 (Small D&E)	\$173.00

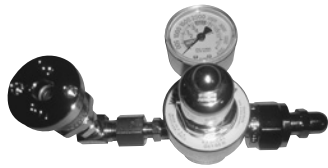

Preset 50 psi with Ohmeda Quick Connect

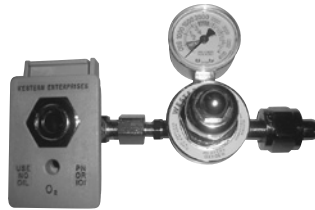

Preset 50 psi with Chemetron Quick Connect



Preset 50 psi with handtight nut (no wrench)



Preset 50 psi with Ohmeda Quick Connect and handtight nut

Gas	Part #	Cylinder Size	Price
Oxy.	MI 540 P-OHFI	CGA 540 (Large)	\$232.00
Air	MI 346 P-OHFI	CGA 346 (Large)	\$232.00
N ₂ O	MI 326 P-OHFI	CGA 326 (Large)	\$232.00

Gas	Part #	Cylinder Size	Price
Oxy.	MI 540 P-CHF	CGA 540 (Large)	\$232.00
Air	MI 346 P-CHF	CGA 346 (Large)	\$232.00
N ₂ O	MI 326 P-CHF	CGA 326 (Large)	\$232.00

Gas	Part #	Cylinder Size	Price
Oxy.	MI 540 PH	CGA 540 (Large)	\$138.00
Air	MI 346 PH	CGA 346 (Large)	\$138.00
N ₂ O	MI 326 PH	CGA 326 (Large)	\$138.00

Gas	Part #	Cylinder Size	Price
Oxy.	MI 540 PH-OHFI	CGA 540 (Large)	\$242.00
Air	MI 346 PH-OHFI	CGA 346 (Large)	\$242.00
N ₂ O	MI 326 PH-OHFI	CGA 326 (Large)	\$242.00



Preset 50 psi with Chemetron Quick Connect and handtight nut



Preset 50 psi with Ohmeda Quick Connect



Preset 50 psi with Chemetron Quick Connect



Gas: Oxy
CGA 540 (Large)

Part #: MPR-501
\$154.00

Gas	Part #	Cylinder Size	Price
Oxy.	MI 540 PH-CHF	CGA 540 (Large)	\$242.00
Air	MI 346 PH-CHF	CGA 346 (Large)	\$242.00
N ₂ O	MI 326 PH-CHF	CGA 326 (Large)	\$242.00

Gas	Part #	Cylinder Size	Price
Oxy.	MR 870 P-OHFI	CGA 870 (Small D&E)	\$234.00
Air	MI 950 P-OHFI	CGA 950 (Small D&E)	\$234.00
N ₂ O	MI 910 P-OHFI	CGA 910 (Small D&E)	\$234.00

Gas	Part #	Cylinder Size	Price
Oxy.	MR 870 P-CHF	CGA 870 (Small D&E)	\$234.00
Air	MI 950 P-CHF	CGA 950 (Small D&E)	\$234.00
N ₂ O	MI 910 P-CHF	CGA 910 (Small D&E)	\$234.00

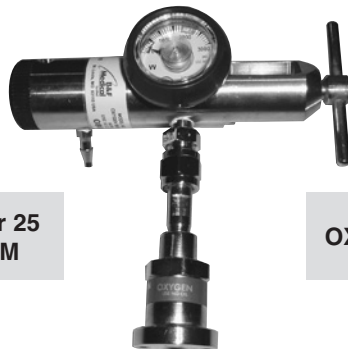

15 or 25 LPM

OXYGEN

Allied 0 - 15 Lpm Small Cylinder (870) Fixed Flow Regulator with Ohmeda 50 psi outlet and DISS 50 psi outlet

21012-OHFI.....\$274.00

25 Lpm - 21025-OHFI.....\$274.00



15 or 25 LPM

OXYGEN

Allied 0 - 15 Lpm Small Cylinder (870) Fixed Flow Regulator with Chemetron 50 psi outlet and DISS 50 psi outlet

21012-CHF.....\$264.00

25 Lpm - 21025-CHF.....\$264.00

Western Medica Oxygen Regulators

(Diaphragm Type)

6 Year Warranty

MRI Safe



115 LPM Flood

Single stage flowmeter/regulator for large cylinders. 15 liters per minute.

ORDER #M1-540-15 FM.....\$181.00

Single stage flowmeter/regulator for small cylinders. 15 liters per minute.

ORDER #M1-870-15 FM.....\$187.00



15 LPM

Single stage, swivel yoke regulator for small cylinders. 15 liters per minute.

ORDER #MR-870-15 FG.....\$139.00

With Gauge-Savers

ORDER #MR-870-15 FGP.....\$163.00

All Western Medica Oxygen Regulators include plastic nut & nipple



15 LPM

Single stage regulator for large cylinders. 15 liters per minute.

ORDER #M1-540-15 FG.....\$139.00

With Gauge-Savers

ORDER #M1-540-15 FGP.....\$163.00



15 LPM

Single stage regulator for small cylinders. 15 liters per minute.

ORDER #M1-870-15 FG.....\$139.00

With Gauge-Savers

ORDER #M1-870-15 FGP.....\$163.00

To order 8 or 5 liter regulators, add an 8 or a 5 to the end of our part number. The price is the same as our 15 liter regulators.



Gauge Savers (Green Rubber)



Gauge Savers Help:

- reduce repair costs
- save downtime
- keep regulators "in service"



.5 - 15 lpm Regulator
Part #. RR800-310M1... \$189.00

E Cylinder Cart
Part #..... CP2152-AL... \$189.00

E Cylinder
Part #..... K870E/MRI... \$177.00

Preset 50 psi Oxygen Regulator

1 - 15 LPM Oxygen Regulator with (2) 50 psi Ports



M1A-870-P
\$134.00



M1A-540-P
\$134.00



M1-540-PH
\$138.00

For Small Cylinders (C,D,E) CGA 870

For Large Cylinders (H,K,M) CGA 540



All Brass!

Part # MPR-802 \$277.00

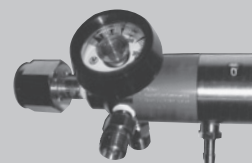

GREAT FOR EMERGENCY BACKUP!

Part # MPR-502 \$277.00

15 LPM Regulator/Flowmeter for large cylinder with 50 psi valve

EMERGENCY BACKUP

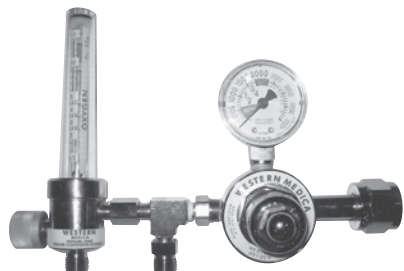

Oxygen M1-540-15FMPTO\$272.00
Air..... M1-346-15FMPTO\$288.00

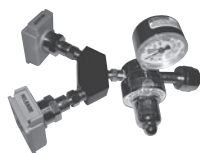

50 psi Large Cylinder Regulator with dual CHEMETRON female couplers

Gas	Part #	Price
Oxygen	M1-540P-2CHF	\$304.00
Air	M1-346P-2CHF	\$328.00



50 psi Large Cylinder Regulator with dual OHMEDA female couplers

Gas	Part #	Price
Oxygen	M1-540P-2OHFI	\$304.00
Air	M1-346P-2OHFI	\$328.00

For air, add an "A" to end of the part number



Provides 2 patients oxygen off a large cylinder

Part #M1540-P2F
\$259.00



Same as unit above, but also has (2) 50 psi auxiliary valves

Part #M1540-P2FPT2
\$297.00

MIXED GAS REGULATORS

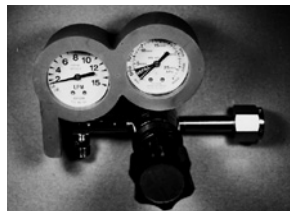

0 - 100 p.s.i.

Part #	Price	Inlet Connection	Outlet	With Gauge Saver	
				Part #	Price
M1-280-PG	\$157.00	CGA-280 Nut Nipple	Unassigned O ₂ -He<80% O ₂ CO ₂ <7.0%	M1-280-PGP	\$179.00
M1-280-PGH	\$180.00	CGA-280 Handtight	Unassigned O ₂ -He<80% O ₂ CO ₂ <7.0%	M1-280-PGHP	\$202.00
M1-890-PG	\$160.00	CGA-890 Yoke	O ₂ -He<80%	M1-890-PGP	\$182.00
M1-880-PG	\$160.00	CGA-880 Yoke	O ₂ CO ₂ <7.0%	M1-880-PGP	\$182.00
M1-500-PG	\$164.00	CGA-500 Nut Nipple	O ₂ CO ₂ >7.0%	M1-500-PGP	\$186.00
M1-500-PGH	\$184.00	CGA-500 Handtight	O ₂ CO ₂ >7.0%	M1-500-PGHP	\$206.00
M1-940-PG	\$188.00	CGA-940 Yoke	O ₂ CO ₂ >7.0%	M1-940-PGP	\$210.00
M1-580-PG	\$160.00	CGA-580 Nut Nipple	O ₂ -He>80%	M1-580-PGP	\$182.00
M1-580-PGH	\$180.00	CGA-580 Handtight	O ₂ -He>80%	M1-580-PGHP	\$202.00
M1-930-PG	\$164.00	CGA-930 Yoke	O ₂ -He>80%	M1-930-PGP	\$186.00

Deluxe Balloon Inflator



Deluxe Balloon Inflator for CGA-580 large cylinder

Part #RPB - 6HG
Price..... \$98.00

Helium

NITROGEN REGULATOR for Ceiling Mounts (Operating Tools)



Designed to be used with the nitrogen outlets. Together they provide pneumatic instruments with varying pressures as required for operation.

Inlet: DISS (twist on)
Outlet: Schrader female
Operating range: 5 - 180 psig
Pressure gauge: 0 - 300 psig
High Flow: 16 -18 scfm

Part Number - 11-20-0007
\$587.00

Nitrogen Regulator



For Large Cylinder (CGA 580) up to 180 psi
Part # MSG 180580..... \$259.00



SCHRADER Outlet (for the above regulator)
Part # 6258N..... \$85.50

WESTERN MEDICA MEDICAL REGULATORS (AIR or CARBON DIOXIDE)

Single-stage regulators preset to 50 psi or adjustable to 100 psi, or with a flowmeter. A sensitive neoprene diaphragm assembly provides optimum accuracy and sensitivity. Dual inlet filtering. Available for small or large cylinders.

		AIR	CO ₂
Preset 50 PSI		M1-346P \$168.00 for large cylinder	M1-320P \$160.00 for large cylinder
Adjustable 0 - 100 PSI		M1-346PG \$184.00 for large cylinder	M1-320PG \$188.00 for large cylinder
Liters Per Minute (lpm)		M1-346-15FM \$212.00 for large cylinder	M1-320-12FM \$210.00 for large cylinder
Preset 50 PSI		M1-950P \$173.00 for small cylinder	M1-940P \$173.00 for small cylinder
Adjustable 0 - 100 PSI		M1-950PG \$189.00 for small cylinder	M1-940PG \$188.00 for small cylinder
Liters Per Minute (lpm)		M1-950-15FM \$209.00 for small cylinder	M1-940-12FM \$213.00 for small cylinder

Dual Nitrogen Regulator

Dual nitrogen single-stage high purity regulator.
Delivery Range: 0 - 180 psi. 6 year warranty.
Comes with Schrader quick connects as shown.

Part # MSH2-180580-SHF2.....\$757.00

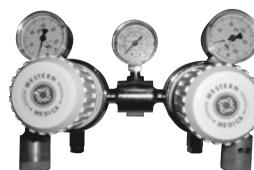

Back of unit has
CGA 580 inlet

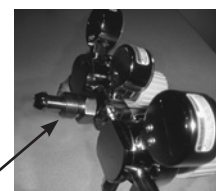

Heliox Regulators



0 - 20 LPM

Part #	Ratio	For Cylinder size	Price
2210-20	70 - 30	Small D and E CGA 890 Yoke	\$297
2211-20	80 - 20	Small D and E CGA 890 Yoke	\$297
2212-20	70 - 30	Large CGA 280 Nut/Nipple	\$289
2213-20	80 - 20	Large CGA 280 Nut/Nipple	\$289

Simple Outlet Expansion allows your hospital to use its existing outlets, and to create the number and placement of outlets needed. Simply mount a length of our rail on the wall - attach the needed outlets to the rail with our thumb screw clamp - attach a length of high-pressure hose to the block, and run it back to your existing outlet.

**That's
Simple
Outlet
Expansion!**

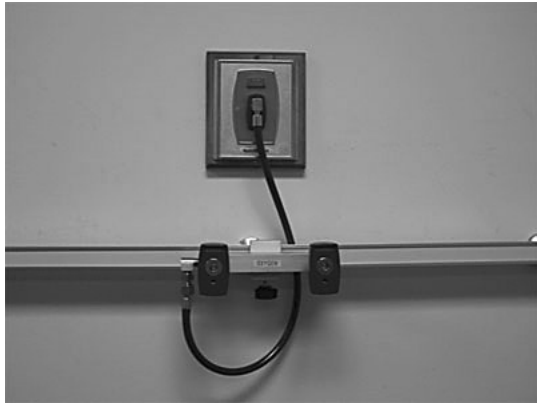

Kit comes with:

- 1 each 2 Foot Rail
- 2 each Mounting Hardware
- 1 each 3 Foot Hose with Wall Adapter
- 1 each Double Gas Block

Outlet connection

DISS
Chemetron
Ohmeda

DISS
Chemetron
Ohmeda

DISS
Chemetron
Ohmeda



- 1 each 4 Foot Rail
- 3 each Mounting Hardware
- 2 each 3 Foot Hose with Wye and Wall Adapter
- 2 each Single Gas Block

DISS
Chemetron
Ohmeda

DISS
Chemetron
Ohmeda

DISS
Chemetron
Ohmeda

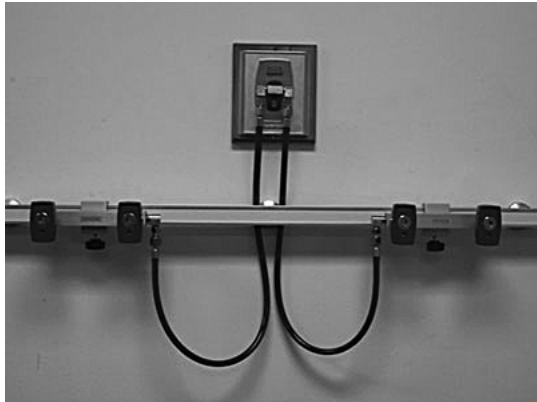

- 1 each 4 Foot Rail
- 3 each Mounting Hardware
- 2 each 3 Foot Hose with Wye and Wall Adapter
- 2 each Double Gas Block

DISS
Chemetron
Ohmeda

DISS
Chemetron
Ohmeda

DISS
Chemetron
Ohmeda

See chart to the right for different outlets for gas blocks

RAIL SYSTEMS

- Easy external mounting - no need to shut down the unit.
- No more weight on outlets
- Shift the weight of humidifiers & suction bottles to the rail
- Eliminate overloading
- Reduce outlet leakage. Save time and money
- Increase efficiency
- Works with all piping systems
- Have outlets where you need them NOW!

GAS	Part #	Price	with 2 flowmeters or 2 continuous suction regulators	
			Part #	Price
Oxygen	ERO-1DS	429.00	ERO-1DS2F	499.00
Oxygen	ERO-1CH	547.00	ERO-1CH2F	637.00
Oxygen	ERO-1OM	547.00	ERO-1OM2F	637.00
AIR	ERA-1DS	429.00	ERA-1DS2F	499.00
AIR	ERA-1CH	547.00	ERA-1CH2F	637.00
AIR	ERA-1OM	547.00	ERA-1OM2F	637.00
VAC	ERV-1DS	429.00	ERV-1DS2R	689.00
VAC	ERV-1CH	547.00	ERV-1CH2R	829.00
VAC	ERV-1OM	547.00	ERV-1OM2R	829.00
Oxygen	ERO-2DS	599.00	ERO-2DS2F	689.00
Oxygen	ERO-2CH	729.00	ERO-2CH2F	829.00
Oxygen	ERO-2OM	729.00	ERO-2OM2F	829.00
AIR	ERA-2DS	599.00	ERA-2DS2F	689.00
AIR	ERA-2CH	729.00	ERA-2CH2F	829.00
AIR	ERA-2OM	729.00	ERA-2OM2F	829.00
VAC	ERV-2DS	599.00	ERV-2DS2R	1199.00
VAC	ERV-2CH	729.00	ERV-2CH2R	1159.00
VAC	ERV-2OM	729.00	ERV-2OM2R	1159.00
Oxygen	ERO-4DS	749.00	ERO-4DS2F	839.00
Oxygen	ERO-4CH	879.00	ERO-4CH2F	1089.00
Oxygen	ERO-4OM	879.00	ERO-4OM2F	1089.00
AIR	ERA-4DS	749.00	ERA-4DS2F	839.00
AIR	ERA-4CH	879.00	ERA-4CH2F	1089.00
AIR	ERA-4OM	879.00	ERA-4OM2F	1089.00
VAC	ERV-4DS	749.00	ERV-4DS2R	1349.00
VAC	ERV-4CH	879.00	ERV-4CH2R	1539.00
VAC	ERV-4OM	879.00	ERV-4OM2R	1539.00

ACCESSORIES

Rail-Mounted Double Gas Blocks

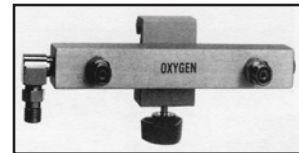

Double Block with DISS Male Fittings

Has Check Valves, inlet can be installed left or right

Part # 9800
\$265.00

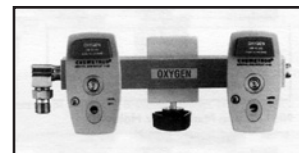

Double Block with Chemetron Couplers

Two Chemetron Couplers, DISS inlet and clamp. Inlet can be installed left or right

Part # 9814
\$305.00

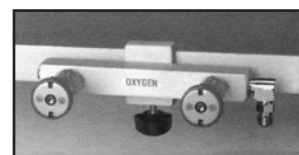

Double Block w/ Ohmeda-Style Couplers

Inlet can be installed left or right

Part # 9843
\$305.00

Rail-Mounted Single Gas Blocks

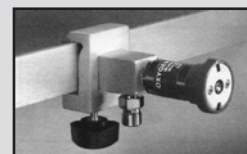

Single Block w/ Ohmeda-Style Coupler

One Ohmeda Style Coupler, DISS bottom inlet and clamp.

Part #9794\$200.00



Single Block w/ Chemetron-Style Coupler

One Chemetron Coupler, DISS bottom inlet and clamp.

Part #9793\$200.00



Single Block

One male DISS check valve, one DISS inlet and clamp

Part # 9789 \$122.00

Please specify gas by adding an "O", "A", or "V" to the end of Part Number

Rail Only - Part # 8000.....\$28.00 per foot

Mounting Kit - Part # 8003.....\$37.00 each
(requires 2 for a 2 foot rail)

REPLACEMENT RESPIRATORY OXYGEN SENSORS



Part # SS-05

OEM Model / Sensor:
Hudson 5577 / 5500
Hudson 6477 / 5500
Hudson 5590 / 5500
Teledyne R13



Part # SS-03

OEM Model / Sensor:
Newport OM100 / T-7
Newport VM200 / T-7
Sechrist 650 / 43170
Teledyne 60T / T-7
Teledyne 191 / T-7
Teledyne 200 / T-7
Hudson / 5558



Part # SS-11A

OEM Model / Sensor:
Bird 6400 / 66030
Bird 8400 / 66030
Lifecare PLV-102 / 37-079
All MiniOx/406931
Puritan Bennett 7200 Vent &
7820 Monitor / 4-020933
Respironics Esprit / 1001454
Hudson / 5567



Part # SS-25A

OEM Model / Sensor:
Maxtec OM-25A / 250E
Maxtec OM-25ME / 250E



Part # SS-250

OEM Model / Sensor:
Maxtec OM-25A / 250



Part # SS-12A

OEM Model / Sensor:
Hamilton Aladdin / 51254
Hamilton Galileo / 51254
Hamilton Raphael / 51254
Infrasonic Adult Star / 6011
Marquet Saracap
Puritan Bennett 760 & 840
Ventilators / 4-074925-00
Siemens 300 / 6419332
Siemens 900 / 9004979
Siemens Servo 710 / 9004979
Spacelab / 90514
Hudson / 5566
Replaces
Teledyne R22
MSA 472062

Unconditional 12 month Warranty!
Exceptional Quality and Performance!
Canned for increased shelf life and freshness!



SS-08i

For Use with:
P1000I Analyzer



SS-10A

Replaces
Ohmeda 0237-2034-700



SS-26

Replaces:
MSA 806572



SS-01

Replaces:
Teledyne T1 & T2



SS-12AIR

For Use With:
Airshields Incubators



SS-12CC

For Use With:
Criticare Monitors



SS-14A

Replaces:
Drager 68-50645



SS-08A

For Use With:
P1000E Analyzer



SS-20A

Replaces Ohmeda:
6050-0004-110

All Sensors \$127.00
(in shaded area)

Replacement Sensors for Hudson



Part # SS-02

OEM Model / Sensor:
Hudson 5525 / 5565
Hudson 5528 / 5565
Hudson 5550 / 5565
Hudson 5552 / 5565



New Part #

Replaces Old Hudson Part #

Price

108P05

5811

\$195.00



122P01

5803

195.00



122P05

5804

195.00

OXYGEN ANALYZER

DIGIT® FINGER OXIMETER



MiniOX® I Oxygen Analyzer

For spot checking oxygen concentrations, the MiniOX I Oxygen Analyzer is the preferred choice of healthcare professionals. This portable unit comes with battery life indicators, an easy-to-use thumb wheel calibration dial, and a push-button ON/OFF switch. Powered by one 9-volt battery, the MiniOX I Oxygen Analyzer provides up to 1400 hours of use.

Each MiniOX I Oxygen Analyzer is shipped ready-to-use, complete with oxygen sensor, coiled cable, tee adapter, battery and operations manual.

Part # 473030
\$629.00

MiniOX® 3000 Oxygen Monitor



When your oxygen analysis calls for continuous monitoring, the MiniOx 3000 Oxygen Monitor is the obvious choice. Portable and easy to use, the MiniOx 3000 Oxygen Monitor is perfect for "in line" oxygen monitoring in such applications as hospital and home ventilators, NICU, and anesthesia delivery equipment.

The MiniOx 3000 Oxygen Monitor feature high and low oxygen concentration alarms, automatic calibration, battery life indicators with alarms, sensor/cable disconnect alarm, and an alarm verification indicator. Powered by one 9-volt battery, the MiniOx 3000 Oxygen Monitor provides up to 1500 hours of use.

Each MiniOx 3000 Oxygen Monitor is shipped ready-to-use, complete with oxygen sensor, coiled cable, tee adapter, battery and operations manual.

Part # 814365.....\$979.00



The Digit® Finger Oximeter is a Pulse Oximeter and Sensor in one unit providing fast, reliable SpO₂, pulse rate and pulse strength measurements on patients from pediatric to adult. Its pocket-size with a large LED Display, one button keypad and auto power shutdown after 8 seconds when not in use, makes it ideal for emergency, hospital or clinical environments, or for home use.

#3420Y (yellow)\$395.00

MINIOX REPLACEMENT PARTS

PART #	DESCRIPTION	PRICE
472045	Coiled Cable	\$98.00
SS-11A	Oxygen Sensor	\$127.00
473021	Tee Adapter	\$14.00

NEB BLOCK w/ FLOWMETER

Features:

- The Neb Block allows a gas outlet to simultaneously or individually provide various respiration treatments without disconnecting any tubing or equipment.
- Provides easy to use On/Off switch to quickly access oxygen flow to a hand held nebulizer or resuscitation bag.
- Reliable fixed flow orifices provide six ranges of flow for aerosol therapy or resuscitation.

6-7 LPM	8-9 LPM	14-16 LPM
7-8 LPM	10-11 LPM	24-25 LPM



NEB BLOCK ONLY

Neb Drive	Part Number
6-7 lpm	NB6060
7-8 lpm	NB6070
8-9 lpm	NB6080
10-11 lpm	NB6100
14-16 lpm	NB6150
24-26 lpm	NB6240
Price	\$89.00



Ohmeda



Chemetron (NCG)



Oxequip

6-7 LPM	8MFA6065	130.00
7-8 LPM	8MFA6075	130.00
8-9 LPM	8MFA6085	130.00
10-11 LPM	8MFA6105	130.00
14-16 LPM	8MFA6155	130.00
24-26 LPM	8MFA6245	130.00
6-7 LPM	8MFA6066	129.00
7-8 LPM	8MFA6076	129.00
8-9 LPM	8MFA6086	129.00
10-11 LPM	8MFA6106	129.00
14-16 LPM	8MFA6156	129.00
24-26 LPM	8MFA6246	129.00
6-7 LPM	8MFA6067	129.00
7-8 LPM	8MFA6077	129.00
8-9 LPM	8MFA6087	129.00
10-11 LPM	8MFA6107	129.00
14-16 LPM	8MFA6157	129.00
24-26 LPM	8MFA6247	129.00



DISS Female Hex Nut



DISS Female Hand Tight



Puritan Bennett

6-7 LPM	8MFA6062	127.00
7-8 LPM	8MFA6072	127.00
8-9 LPM	8MFA6082	127.00
10-11 LPM	8MFA6102	127.00
14-16 LPM	8MFA6152	127.00
24-26 LPM	8MFA6242	127.00
6-7 LPM	8MFA6063	129.00
7-8 LPM	8MFA6073	129.00
8-9 LPM	8MFA6083	129.00
10-11 LPM	8MFA6103	129.00
14-16 LPM	8MFA6153	129.00
24-26 LPM	8MFA6243	129.00
6-7 LPM	8MFA6068	123.00
7-8 LPM	8MFA6078	123.00
8-9 LPM	8MFA6088	123.00
10-11 LPM	8MFA6108	123.00
14-16 LPM	8MFA6158	123.00
24-26 LPM	8MFA6248	123.00

PEDIATRIC FLOWMETERS



0-200 cc (in 25 cc increments)

Part #	Adapter	Price
6MFA1001	None - 1/8" NPT Female	\$259.00
6MFA1002	Diss Female	264.00
6MFA1003	Diss Female w/hand nut	265.00
6MFA1006	Chemetron (NCG)	274.00
6MFA1005	Ohio (Ohmeda)	275.00
6MFA1008	Puritan	269.00
6MFA1009	Schrader	276.00
6MFA1007	Oxequip	274.00

0-1 LPM BY WESTERN MEDICA WITH ADAPTER

Part #	Adapter	Price
4MFA1001	None - 1/8" NPT Female	\$220.00
4MFA1002	Diss Female	231.00
4MFA1003	Diss Female w/hand nut	233.00
4MFA1006	Chemetron (NCG)	238.00
4MFA1005	Ohio (Ohmeda)	242.20
4MFA1008	Puritan	233.00
4MFA1009	Schrader	247.50
4MFA1007	Oxequip	237.70

COMPRESSORS AND NEBULIZERS

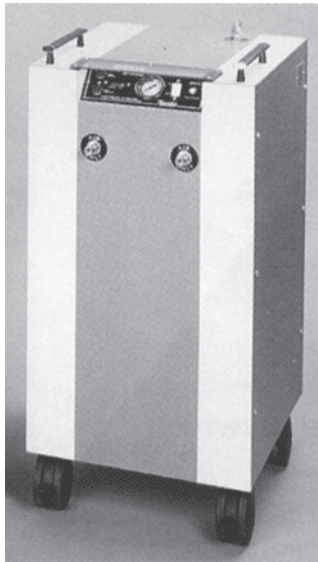

Uniquely designed for bed-side use. Special material absorbs most noise for quiet performance. Audible and visual high temperature and low pressure alarms with DC powered six-volt backup. Vibration-free gauge shows diminished pressure, impaired drying or exceeded flow capacity. Circuit breaker and thermal overload protector included. Continuous flow of 64 LPM at 50 psi.

Part Number TE20 \$4550.00

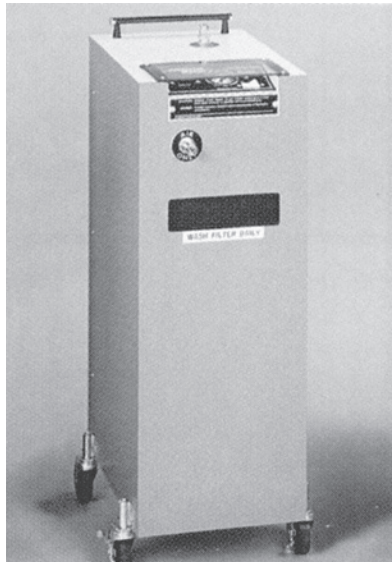

Designed for bedside use. Quiet, vibration-free performance. Provides condensation-free compressed air to respiratory therapy equipment. Vibration-free gauge shows diminished pressure, impaired drying or exceeded flow capacity. Circuit breaker and thermal overload protector included. Continuous flow of 42 LPM at 50 psi.

Part Number TE35 \$3880.00

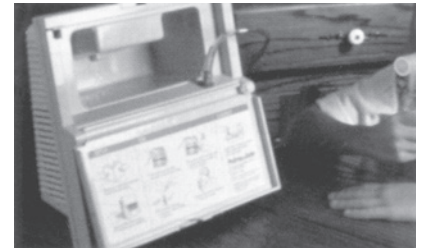

DeVilbiss Pulmo-Aide® Medication Nebulizer

Durable AC-powered medication nebulizer with Pulmo-Neb® 60-day disposable nebulizer and tubing. Unit weighs 7 lbs. and has 9 - 16 LPM range. 5 year warranty.

3-Prong Plug
DV4650D\$180.00

PRECISION MEDICAL "EASY AIR" COMPRESSOR

Hospital Grade Plug



The Easy Air 15 proves that bigger isn't always better

It's just as powerful...

No sacrificing power with the Easy/Air. We've put the same power & flow you're used to, 14 lpm at 50 psi, in a much smaller package.

It's Lightweight...

The Easy/Air weighs only 19 lbs. making it much easier to carry. It is an average of 48% lighter than comparable compressors.

It's Compact...

An average of 37% smaller than other units, it fits into areas where space is at a minimum.

It's Easy to Use...

We've eliminated the need for pressure/flow calculations with a built-in flow gauge. This unique feature allows the care-giver to set the air flow in LPM by simply dialing in the desired flow. The unit is also available with a standard pressure gauge.

It Aids Compliance...

The unique built-in elapsed time indicator aids in determining when preventative maintenance is due. This money saving feature helps compliance with JCAHO maintenance record keeping.

It's Easy to Maintain...

For the first time ever, both the external and internal compressor filters are on the outside of the cabinet making filter cleaning easier and more accessible for patients and caregivers.

It's Durable...

The ABS plastic cabinet is durable, attractive, easy-to-clean and infection control friendly.

It's Safe...

Safety is assured with the internal time delay circuit breaker which protects the unit from overheating.

SCHUCO S5000 NEBULIZER



Introducing the Schuco® S5000 Nebulizer ... Combining Schuco quality and reliability with an affordable price.

- Suppressed sound
- Enhanced airflow
- Easy to use and clean
- Our most cost-effective nebulizer

Complete with all that's needed to begin nebulizer therapy:

- Compact compressor
- Nebulizer cup
- Angled mouthpiece
- Over six feet of oxygen tubing
- Five extra compressor filters
- 2-year limited warranty

Part Number S5000\$99.00

Part #	Description	Price
PM15F	Compressor with liter per minute (lpm) gauge	\$669.00
PM15P	Compressor with 0 - 100 pressure gauge	\$669.00
PM60-1	5 Wheel Stand	\$189.00

PEAK FLOWMETERS

Mini-Wright Peak Flowmeter



Mini-Wright Peak-Flow Meters

The Standard mini-Wright is tubular, with a spring-loaded piston and a longitudinal slot through which air escapes. The scale reads from 60 to 800 liters/minute.

Low Range mini-Wright Peak-Flow Meter

This instrument was developed from the Standard mini-Wright to monitor the low range from 30 to 370 liters/minute. The pediatric patient may be encouraged if they are able to move the pointer an appreciable distance.

Part #	Description	Price
3103104	Adult Standard mini-Wright	\$45.00
281	Adult Plastic Disposable Mouthpiece/144	69.00
3104001	Low Range (Pedi) mini-Wright	45.00
281-P	Pedi Plastic Disposable Mouthpiece/144	69.00

MDI ACCESSORY by Ferraris



The POCKET CHAMBER is equipped with a highly sensitive silicone valve that opens easily without restricting the air flow. This one-way valve helps keep patients from accidentally blowing medication out of the chamber, and may aid patients experiencing difficulty timing their inhalation.

Product Description	Catalog #	Unit/Case	Price
Pocket Chamber Valved Aerosol Holding Chamber	1001-10	10	\$149.00

Nellcor FSII Flow Sensors for Renaissance II and Simplicity Puritan Bennett



Part #	Price	Quantity
P-000263-00	\$139.00	50/cs
P-000265-00	\$679.00	250/cs

Peak Flow Meter - "The PEAK®"



50 - 750 LPM

- Very low priced
- Instructions and color zones printed on the meter
- Available in two attractive colors
- Patient can personalize their meter
- Scale covers pediatric and adult patients
- Documented accuracy and precision
- Exceeds ATS-26 and NAEP standards

Cases of 10

CBI-1202	Blue	\$197.00
CBI-1201	White	\$197.00

Includes: Diary Chart, mouthpiece, and colorful label sheet.

Finally, a valved holding chamber with a "lever actuator" to help users increase leverage on MDI medications has arrived. Introducing BirdSong Medical's LeverHaler, the ideal MDI delivery system for elderly, arthritic, children, or anyone looking to truly improve coordination.



Easy to use!

LH-1000... \$117.00/case of 10
LH-1000E.....\$17.00 each

NOSECLIP

case of 100



#64019 - \$56.00

MDI ADAPTORS



No. 1659..... \$164.00
MDI Adaptor

- 22mm O.D. x 22mm I.D. connections for in-line placement in 22mm tubing
- 50 per case



No. 1751..... \$171.00
MDI Adaptor

- 15mm O.D. x 15mm I.D. connections for in-line placement in 15mm tubing
- 50 per case

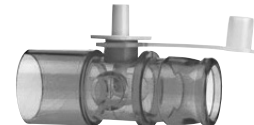

No. 1759..... \$326.00
Dual Spray MDI Adaptor

- Bidirectional nozzle creates a chamber effect
- 22mm O.D. x 22mm I.D. connections
- Dual-spray nozzle directs plumes in both directions simultaneously
- Tethered cap
- Extended universal port
- 50 per case

DISPOSABLES

#2200 Flexible Connector (Silicone Rubber)

22mm I.D. x 22mm I.D.

This adapter was designed almost identical to the ones listed below.

INTEC 2200 • BENNETT 3443 • MARQUEST 172200
AM SYSTEMS 1139 • Instrumentation Ind. 101-00-3443

\$217.00 per case of 50 / \$6.30 each

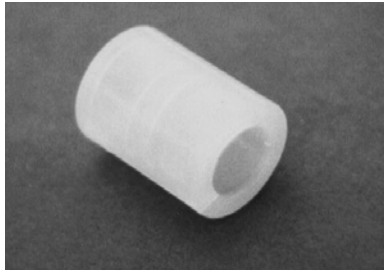

HUDSON RCI

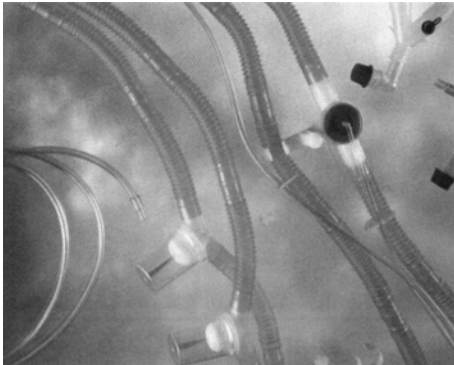

SURE SEAL® MASKS

Cat. No.	Size	Connector Size (mm)	Inflation Port	Ring Color
1271	Neonate	15		White
1272	Infant	15		Pink
1273	Pediatric	22		Yellow
1274	Small Adult	22		Green
1275	Medium Adult	22		Red
1276	Large Adult	22		Blue
1277	Neonate	15	•	White
1278	Infant	15	•	Pink
1279	Pediatric	22	•	Yellow
1280	Small Adult	22	•	Green
1281	Medium Adult	22	•	Red
1282	Large Adult	22	•	Blue

SURE SEAL face masks incorporate specially designed nose area and comfortable, gas-tight, low pressure seal.

- Color coded retaining rings are removable for hand-held procedures

- Available with optional inflation port for customized fit and comfort

- Individually packaged 20 to a case

\$94.00 / cs of 20

VENTILATOR CIRCUITS

Adult Standard Ventilator Circuit, 72" long. Use on Puritan-Bennett 7200A; Servo 300, 900A, 900B and 900C; Hamilton Veolar; Emerson; Engstrom Erica; PPG Irisa; Infrasonics Adult Star and Bird 8400ST.

HU1613..... \$94.00 10/cs

Adult Standard Ventilator Circuit, 72" long. Use on Bear 1, Bear 2, Bear 3; Puritan-Bennett MA-1; MA-2, MA 2+2, 7200 (early models); Monaghan 225 and Newport Adult.

HU1625..... \$153.50 10/cs

Adult standard Ventilator Circuit. 72" tubing set with external exhalation valve and 1/4" monitoring tubing. Conventional back to top.

HU1627..... \$124.50 10/cs

Pediatric Ventilator Circuit with dual heated limbs, monitoring tubing and "humidifier line". 48".

HU780-25..... \$479.50 20/cs

Neonatal Ventilator Circuit with proximal temperature port with water trap. 48" long.

HU780-11 \$300.00 20/cs

CORRUGATED TUBING



**No. 1680
\$27.00 per roll**

- Continuous 100-ft. roll of tubing with cuttable 6-inch sections
- Packaged in protective, convenient, plastic-lined dispenser box

UNIVERSAL IPPB CIRCUIT



Universal IPPB Circuit has sensitive exhalation valve with clear cap, expiratory flow diverter, high-output 20 ml. nebulizer, mouthpiece, 6" and 39" Corr-A-Flex® tubing, multiple adaptor kit and exhalation valve drivelines

1560 \$296.00 50/cs
1560H \$169.00 25/cs

AEROSOL DRAINAGE BAGS

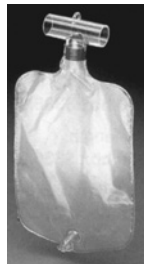

Disposable Aerosol Drainage Bags with tee adaptor fits 22mm ID corrugated tubing. Bag has plastic chain for securing and convenient drainage port. 750 cc capacity

**HU1740
\$106.50 50/cs**

Same as above with wye adaptor
**HU1742
\$126.00 50/cs**

MDI ADAPTER

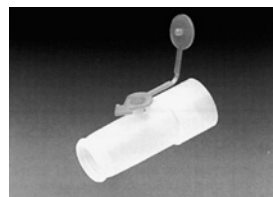

No. 1659 \$164.00

- Standard 22 mm I.D./O.D. connections for placement in-line
- Tee adapter with arrow allows therapist to direct aerosolized medication toward patient or away for "reservoir" effect
- Fits most standard canisters
- Individually packaged 50 to a case

TEST LUNG (Latex Free)



Part #	Capacity	Price
LF-113	500cc	\$44.00
78175AP	1 Liter	\$44.00

EMERGENCY LIFESAVER KIT

Kit contains 7 sizes of disposable Cath-guide Airways, 55mm - 115mm, in a sturdy, compact case with flanged connectors

HU1173 each \$38.26

IMV SYSTEM



Complete IMV System with humidifier manifold, 3 liter reservoir bag, anti-suffocation valve and 7' of oxygen tubing

**HU1652
\$163.50 15/cs**

Basic IMV System with humidifier manifold and reservoir tee with 22mm oxygen adaptor

**HU1654
\$73.50 15/cs**

ONE-WAY VALVES

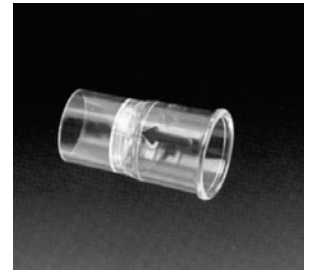

No. 1665 \$61.00
One-Way Valve

- Valve offers low flow resistance in one direction, from 22 mm I.D. to 22 mm O.D.
- Individually packaged 50 to a case

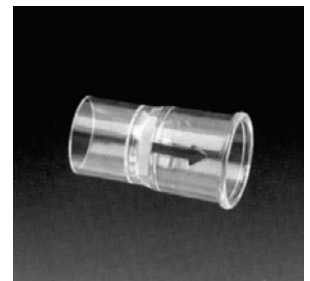

No. 1664 \$61.00
One-Way Valve

- Valve offers low flow resistance in one direction, from 22 mm O.D. to 22 mm I.D.
- Individually packaged 50 to a case

HUDSON RCI DISPOSABLE THERMOMETERS, WATER TRAPS, ADAPTERS & CONNECTORS

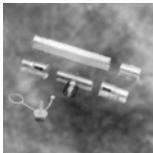

No. 1667 \$173.00
Ventilator Monitoring Adaptor Circuit

- Allows monitoring of ventilatory weaning parameters in intubated patients
- Includes oxygen nipple adaptor, aerosol tee, 6" CORR-A-FLEX tube, 15mm/22mm adaptor, m/m one-way valve and m/f one-way valve
- 50 per case

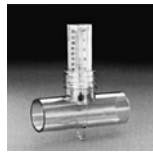

No. 1637 \$147.00
Thermometer with Tee Adapter

- Combines No. 1635 Thermometer and No. 1077 Aerosol Tee Connector
- Packaged 50 to a case



No. 1647 \$144.00
Thermometer with Thermometer Adapter

- Combines No. 1635 Thermometer and No. 1645 Thermometer Adapter
- Packaged 50 to a case

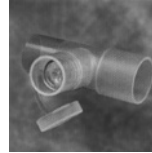

No. 1743 \$212.00
Valved Neb Tee

- 22mm O.D. x 18mm I.D. x 22mm I.D. connections
- Tee may be left in-line when nebulizer is removed
- Port accepts most small volume nebulizers
- 30 per case

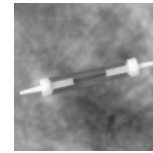

No. 1679 \$33.00
Oxygen Tubing Water Trap

- Collects moisture that may collect during oxygen therapy
- Accepts all standard and crush resistant oxygen connection tubing
- 10 per case

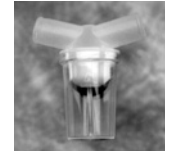

No. 1650 \$181.00
Water Trap

- 70cc capacity
- 22mm O.D. x 22mm O.D. tubing connections
- Self-sealing lid to ensure circuit patency
- 50 per case



No. 1078 \$59.00
Ventilator Adaptor

- Right angle adaptor with a capped suction port
- Vertical axis has a 15mm I.D. and horizontal axis has 22mm O.D.
- Packaged 50 to a case

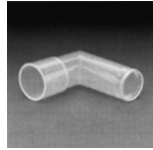

No. 1641 \$62.00
Elbow Adaptor

- Standard 22mm I.D. connector on vertical axis
- 22mm O.D. connection on horizontal axis
- Packaged 50 to a case



No. 1642 \$81.00
Pressure Line Adaptor

- 22mm I.D./O.D. connections
- Barbed elbow accepts 5 to 7mm I.D. tubing and swivels 360 degrees
- Packaged 50 to a case

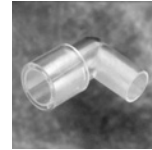

No. 1623 \$141.50
Patient Elbow Adaptor

- 15mm O.D. x 15mm I.D./22mm O.D.
- 50 per case



No. 1673 \$68.00
Ported Elbow Adaptor

- Standard 22mm I.D./22mm O.D. Connections
- Accepts most temperature probes
- 50 per case



No. 1648 \$44.00
Aerosol Tee Connector

- 22mm O.D. x 15mm I.D./22mm O.D. x 22mm O.D.
- 50 per case

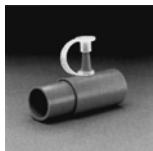

No. 1644 \$104.00
One-Way Valve

- Standard 22 mm I.D./O.D. connections
- Valve offers low flow resistance and a capped monitoring port
- Packaged 50 to a case

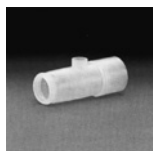

No. 1645 \$60.00
Thermometer Adapter

- Standard 22 mm I.D./O.D. connections
- Multipurpose port accepts most temperature probes and thermometers
- Packaged 50 to a case



No. 1638 \$62.00
Aerosol Tee Connector

- Horizontal ports of the tee are 22mm O.D.
- Vertical port is 18mm I.D./22mm O.D.
- Packaged 50 to a case

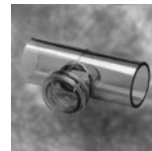

No. 1077 \$48.00
Aerosol Tee Connector

- Anti-spill design minimizes aspiration of liquids
- Horizontal axis has standard 22mm O.D. connections
- Vertical axis incorporates a standard 15mm I.D. connection and two 22mm O.D. concentric rings
- Packaged 50 to a case

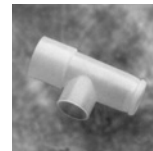

No. 1639 \$63.00
Nebulizer Tee Connector

- Standard 22 mm I.D./O.D. connections
- Nebulizer port is 18mm I.D. which accepts most small volume nebulizers
- Packaged 50 to a case



No. 9059 \$342.00
Adaptor with O₂ Port

- Standard 22mm O.D. x 22mm I.D. connections
- Capped port
- 250 per case



No. 1421 \$63.00
Universal Cuff Adaptor

- Standard 22mm I.D. connections
- Packaged 50 to a case



No. 1422 \$66.00
Multi Adaptor

- Standard 15mm I.D./22mm O.D. connections
- Packaged 50 to a case



No. 1409 \$54.00
Large Tubing Connector

- Standard 22mm O.D. connections
- Packaged 50 to a case



No. 1678 \$93.00
22mm ISO Cuff Adaptor

- 22mm I.D. x 22mm O.D.
- 50 per case



No. 1663 \$104.00
Soft Cuff Adaptor

- Approximately 21mm I.D. x 19mm I.D.
- Made of flexible material
- 50 per case

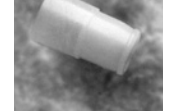

No. 1640 \$68.00
Tubing Adaptor

- Standard 22mm I.D./O.D.
- Packaged 50 to a case



No. 1660 \$124.00
Universal Wye Connector

- All patient connections have 22mm O.D./15mm I.D.
- Wye has ports to monitor airway pressure and temperature
- Packaged 50 to a case



No. 1751 \$171.00
MDI Adaptor

- 15mm O.D. x 15mm I.D. connections for in-line placement in 15mm tubing
- 50 per case



No. 1659 \$164.00
MDI Adaptor

- 22mm O.D. x 22mm I.D. connections for in-line placement in 22mm tubing
- 50 per case



No. 1743 \$212.00
In-line Neb Tee w/Valve

- 22mm O.D. x 18mm I.D. x 22mm I.D. connections
- Port accepts most small volume nebulizers
- Allows tee to be left in-line when nebulizer is removed
- 30 per case



No. 1423 \$104.00
Tubing Adaptor

- 22mm I.D. x 5 - 7mm tapered nipple
- Packaged 50 to a case



No. 1669 \$67.00
Monitoring Adaptor

- 15mm O.D. x 15mm I.D./22mm O.D.
- Standard luer fitting
- 50 per case

No. 1662 \$101.00
Wye Connector

- Same as No. 1660 but without temperature and pressure monitoring ports
- Packaged 50 to a case

HUDSON CANNULAS & OXYGEN MASKS

New Lower Pricing!

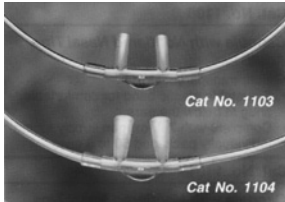

CANNULAS

Part #	Description	List Price	Your Price
H1101	Pediatric, nonflared nasal tips (below the ears)	\$145.50	116.40
H1103	Adult, nonflared nasal tips	46.00	36.80
H1104	Adult, flared nasal tips	46.00	36.80
H1110	Adult, nonflared, star lumen tubing	58.00	46.40
H1111	Adult, flared, star lumen tubing	58.00	46.40

- 7' over the ear
- cases of 50



SECTION OF STAR LUMEN TUBING

kink and crush resistant

AEROSOL MASKS



Part #	Description	List Price	Your Price
H1083	Adult long	\$53.25	42.60
H1084	Adult short	92.00	73.60
H1085	Pedi long	78.00	62.40
H1080	Pedi short	81.00	64.80
H1095	Adult Face Tent	93.00	74.40
H1075	Adult trach	109.00	96.00
H1076	Pedi trach	141.50	118.00

- without tubing
- cases of 50

MEDIUM CONCENTRATION

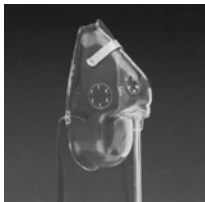

Part #	Description	List Price	Your Price
H1040	Adult short	\$125.00	100.00
H1041	Adult long	76.00	60.80
H1035	Pedi short	102.00	81.60
H1042	Pedi long	101.00	80.80

- with 7' tubing
- cases of 50

HIGH CONCENTRATION



Part #	Description	List Price	Your Price
H1009	Adult short	\$150.00	120.00
H1007	Adult long	109.00	87.20
H1000	Pedi short	172.00	137.60
H1011	Pedi long	136.50	109.20

- with 7' tubing
- cases of 50

SUPPLY LINE ADAPTER

For extending smooth bore oxygen tubing. Tapered for excellent gripping.

#65100.....\$96.00 cs/200

7' SUPPLY TUBING

(50 per case)

#1115.....\$38.00



(7-5A)

Nut and Nipple

Part #	Description	Price
7-4A	One piece Green	\$27.00 cs/50
7-5A	Two piece Green	\$34.00 cs/50
7-5C	Two piece Yellow	\$46.00 cs/50
0159	Metal	\$ 6.80 each
0159C	Metal w/ 6" chain	\$ 7.90 each
7-5H	Two piece Clear	\$46.00 cs/50

E-Z WRAP



Soft closed-cell foam tubes designed to prevent ear chafing. Light gray color. Packed 50 pair per case
Part # 1016
\$63.00 cs/50 pair

HUDSON PREFILLED HUMIDIFIER STERILE WATER

AQUAPAK Sterile Water, 340mL, with Sterile Humidifier Adaptor 040

Micro-diffuser produces smaller bubbles and greater surface agitation for quiet operation and high humidity output.

Catalog # 003-40
 Case of 20 \$93.40



BACTERIAL / VIRAL FILTERS

Main Flow Bacterial / Viral Filter

- 22mm ID x 15mm ID/22mm OD
- Bacterial filtration efficiency 99.999+%
- Viral filtration efficiency 99.99+%
- Dead space: 42mL
- Flow resistance: approximately 1.5 cmH₂O at 60 LPM
- Individually packaged 50 to a case

Catalog # 1605
 Price.....\$193.00

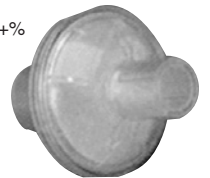

1605

ENDOTRACHEAL TUBE HOLDER



PM1110

- Adult size
- Fully padded to protect lips and teeth
- Sturdy bite block to prevent tube occlusion
- Ideal for ER, OR and Paramedic use

\$36.00 (Case of 10)
 Precision Medical

TRACHEOSTOMY MASKS

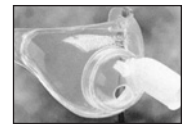

Adult

- For tracheostomy and laryngectomy aerosol therapy
- Tubing connector swivels 360° and accepts 22mm I.D. corrugated tubing

Part # 1075.....\$96.00

Pediatric

- Same as Part # 1075, except pediatric size mask

Part # 1076..... \$118.00
 50 per Case

HUDSON MICRO MIST® NEBULIZER



The Hudson RCI MICRO MIST small volume nebulizer is designed for performance and economy. It can be used for hand-held or in-line treatments. The MICRO MIST includes the design features needed by today's respiratory care practitioners.

- Optimal particle size delivered at efficient nebulization rates
- Consistent performance at angles up to 90 degrees
- Easy-seal, threaded cap and 6cc capacity anti-spill jar to prevent leakage
- Available with 6-in. reservoir tube
- All configurations individually packaged 50 to a case

PATENT NO. RE: 33,642

MICRO MIST Nebulizer

The Hudson RCI MICRO MIST small volume nebulizer delivers a fine, mist at angles up to 90 degrees, allowing clinicians to administer medication to patients positioned horizontally or with special treatment requirements.

With optimal particle size and efficient nebulization rates, the MICRO MIST efficiently delivers medication with minimal residual.

NOSECLIP

case of 100

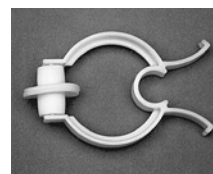

#64019
\$56 .00

HUDSON BUBBLE HUMIDIFIER



Disposable - case of 50
Part # 3230....\$98.50

Reusable
Part # 3100....\$59.50

Catalog #	Description	Pkg.	Price
1880	nebulizer only	50/cs.	\$63.00
1883	nebulizer, tee, mouthpiece, reservoir, 7' supply tube	50/cs.	\$123.00
1885	nebulizer, 7' supply tube, adult mask	50/cs.	\$133.00
1886	nebulizer, 7' supply tube, pediatric mask	50/cs.	\$157.00

"Y" BLOCK ASSEMBLIES

TRI-BLOCK ASSEMBLIES

Ohmeda Style			Chemetron Style			Puritan-Bennett Style			Ohmeda Style "Y" Assembly--"Stubby"			Ohmeda Style		
(Ohio) 			(NCG) 						Compact Version 					
2152	O ₂	182.70	3152	O ₂	174.00	4152	O ₂	161.00	2162	O ₂	189.00	OR301-77-3 O ₂ 256.20		
2252	Air	182.70	3252	Air	174.00	4252	Air	161.00	2262	Air	189.00	OR302-77-3 Air 256.20		
2352	Vac	182.70	3352	Vac	174.00	4352	Vac	161.00	2362	Vac	189.00	OR304-77-3 Vac 256.20		
2452	N ₂ O	182.70	3452	N ₂ O	174.00				2462	N ₂ O	189.00	OR303-77-3 N ₂ O 256.20		

T BLOCKS

OHMEDA Style

Gas	Part #	Price	Gas	Part #	Price	Gas	Part #	Price
Oxy	2152-T	\$197.00	Oxy	2152-R	\$197.00	Oxy	2152-L	\$197.00
Air	2252-T	\$197.00	Air	2252-R	\$197.00	Air	2252-L	\$197.00
Vac	2352-T	\$197.00	Vac	2352-R	\$197.00	Vac	2352-L	\$197.00

CHEMETRON Style

Gas	Part #	Price	Gas	Part #	Price	Gas	Part #	Price
Oxy	3152-T	\$197.00	Oxy	3152-R	\$197.00	Oxy	3152-L	\$197.00
Air	3252-T	\$197.00	Air	3252-R	\$197.00	Air	3252-L	\$197.00
Vac	3352-T	\$197.00	Vac	3352-R	\$197.00	Vac	3352-L	\$197.00

NPT PIPE FITTINGS

Female Tee	Street Tee	Cross	45° Street Elbow
Part No. 1/8" NPT7034 1/4" NPT7035	Part No. 1/8" NPT7032 1/4" NPT7033	Part No. 1/8" NPT7036 1/4" NPT7037	Part No. 1/8" Female x 1/8" Male7056 1/4" Female x 1/2" Male7057
\$5.90	\$5.70	\$10.70	\$5.70
Connectors	Hex Nipple	Hose Barb Connector	Coupler
Part No. 1/8" Female x 1/8" Male7023 1/8" Female x 1/4" Male7024 1/4" Female x 1/8" Male7025 1/4" Female x 1/4" Male7026	Part No. 1/8" Male x 1/8" Male7020 1/8" Male x 1/4" Male7021 1/4" Male x 1/8" Male7022	Part No. 1/8" Male x 1/8" Dia.7038 1/8" Male x 1/4" Dia.7039 1/4" Male x 1/8" Dia.7040 1/4" Male x 1/4" Dia.7043	Part No. 1/8" Female x 1/8" Female.....7027 1/4" Female x 1/4" Female.....7028 1/4" Female x 1/2" Female.....7029
\$5.60	\$5.60	\$5.70	\$5.90
90° Elbow	Plug	Hose Barb Connector	Cap
Part No. 1/8" Female x 1/8" Female.....7058 1/4" Female x 1/4" Female.....7059	Part No. 1/8" NPT7017 1/4" NPT7019	Part No. 1/8" Female x 1/4" Dia.7046 1/4" Female x 1/4" Dia.7049	Part No. 1/8" NPT7016 1/4" NPT7018
\$5.60	\$4.20	\$4.80	\$4.10
Pipe Tee	Drop Ear	Pipe Nipple	90° Elbow
Part No. 1/8" NPT7030 1/4" NPT7031	Part No. Tee 1/8"F x 1/8"F x 1/8"F7081 Elbow 1/8"F x 1/8"F7082	Part No. 1/8" Male x 1 1/2" Long7050 1/8" Male x 2" Long7051 1/8" Male x 2 1/2" Long7052 1/4" Male x 1 1/2" Long7053 1/4" Male x 2" Long7054 1/4" Male x 2 1/2" Long7055 1/8" Male x 3 1/2" Long7062	Part No. 1/8" F x 1/8" M7063 1/4" F x 1/4" M7065
\$5.60	\$17.20	\$9.70	\$5.55

Schrader Style

Oxequip Medstar Style

6152	O ₂	194.00	11-03-0016	O ₂	316.00
6252	Air	194.00	11-03-0017	Air	316.00
6352	Vac	194.00	11-03-0018	Vac	316.00
6252	Air/Nitrogen	194.00			

Y-BLOCK









	M00-70	1/8" NPT Female Inlet to 1/4" NPT Female Outlets
	M00-71	1/4" NPT Female Inlet to 1/4" NPT Female Outlets
\$22.00		

DISS "Y" ASSEMBLY WITH CHECK VALVES









	(M24-76)	
	(M24-77)	
	(7211)	
7211	Diss Female	O ₂ 76.00
M24-76	Chemetron	O ₂ 83.98
M24-77	Ohmeda (Ohio)	O ₂ 85.00
M24-79	Puritan	O ₂ 68.16
3634	Schrader	O ₂ 70.35
M24-78	Oxequip	O ₂ 76.83
7212	Diss Female	Air 76.00
M16-76	Chemetron	Air 90.44
M16-77	Ohmeda (Ohio)	Air 90.44
M16-79	Puritan	Air 78.78
3640	Schrader	Air 71.50
M16-78	Oxequip	Air 81.78
7213	Diss Female	Vac 76.00
M22-76	Chemetron	Vac 90.44
M22-77	Ohmeda (Ohio)	Vac 90.44
M22-79	Puritan	Vac 78.78
3646	Schrader	Vac 71.50
M22-78	Oxequip	Vac 81.78

QUICK CONNECTS (MALE)









Ohmeda

	Gas	Part #	Price
1/8" NPT Male 	Oxygen.....	2101.....	\$34.50
	Air.....	2201.....	34.50
	Vacuum.....	2301.....	34.50
	Nitrous Oxide.....	2401.....	34.50
	WAGD/Evac.....	2601.....	89.00
1/8" NPT Female 	Oxygen.....	2102.....	\$34.50
	Air.....	2202.....	34.50
	Vacuum.....	2302.....	34.50
	Nitrous Oxide.....	2402.....	34.50
	WAGD/Evac.....	2602.....	89.00
1/4" NPT Male 	Oxygen.....	2103.....	\$35.75
	Air.....	2203.....	35.75
	Vacuum.....	2303.....	35.75
	Nitrous Oxide.....	2403.....	35.75
	WAGD/Evac.....	2603.....	89.00
DISS Male 	Oxygen.....	2105.....	\$42.50
	Air.....	2205.....	42.50
	Vacuum.....	2305.....	42.50
	Nitrous Oxide.....	2405.....	42.50
DISS Hex Nut 	Oxygen.....	2106.....	\$42.50
	Air.....	2206.....	42.50
	Vacuum.....	2306.....	42.50
	Nitrous Oxide.....	2406.....	42.50
DISS Hand Tight 	Oxygen.....	2108.....	\$44.00
	Air.....	2208.....	44.00
	Vacuum.....	2308.....	44.00
	Nitrous Oxide.....	2408.....	44.00
1/4" Hose Barb 	Oxygen.....	2111.....	\$41.50
	Air.....	2211.....	41.50
	Vacuum.....	2311.....	41.50
	Nitrous Oxide.....	2411.....	41.50
	WAGD/Evac.....	2611.....	89.00
DISS Male with Check Valve 	Oxygen.....	2114.....	\$46.00
	Air.....	2214.....	46.00
	Vacuum.....	2314.....	46.00
	Nitrous Oxide.....	2414.....	46.00

Chemtron

	Gas	Part #	Price
1/8" NPT Male 	Oxygen.....	3101.....	\$33.00
	Air.....	3201.....	33.00
	Vacuum.....	3301.....	33.00
	Nitrous Oxide.....	3401.....	33.00
	WAGD/Evac.....	3601.....	85.75
1/8" NPT Female 	Oxygen.....	3102.....	\$33.00
	Air.....	3202.....	33.00
	Vacuum.....	3302.....	33.00
	Nitrous Oxide.....	3402.....	33.00
	WAGD/Evac.....	3602.....	85.75
1/4" NPT Male 	Oxygen.....	3103.....	\$34.50
	Air.....	3203.....	34.50
	Vacuum.....	3303.....	34.50
	Nitrous Oxide.....	3403.....	34.50
	WAGD/Evac.....	3603.....	85.75
DISS Male 	Oxygen.....	3105.....	\$39.50
	Air.....	3205.....	39.50
	Vacuum.....	3305.....	39.50
	Nitrous Oxide.....	3405.....	39.50
DISS Hex Nut 	Oxygen.....	3106.....	\$39.50
	Air.....	3206.....	39.50
	Vacuum.....	3306.....	39.50
	Nitrous Oxide.....	3406.....	39.50
DISS Hand Tight 	Oxygen.....	3108.....	\$41.25
	Air.....	3208.....	41.25
	Vacuum.....	3308.....	41.25
	Nitrous Oxide.....	3408.....	41.25
1/4" Hose Barb 	Oxygen.....	3111.....	\$36.50
	Air.....	3211.....	36.50
	Vacuum.....	3311.....	36.50
	Nitrous Oxide.....	3411.....	36.50
	WAGD/Evac.....	3611.....	85.75
DISS Male with Check Valve 	Oxygen.....	3114.....	\$43.00
	Air.....	3214.....	43.00
	Vacuum.....	3314.....	43.00
	Nitrous Oxide.....	3414.....	43.00

Puritan Bennett

1/8" NPT Male 	Gas	Part #	Price	DISS Hex Nut 	Gas	Part #	Price
	Oxygen.....	4101.....	\$23.00		Oxygen.....	4106.....	\$27.00
	Air.....	4201.....	23.00		Air.....	4206.....	27.00
	Vacuum.....	4301.....	23.00		Vacuum.....	4306.....	27.00
	Nitrous Oxide.....	4401.....	23.00		Nitrous Oxide.....	4406.....	27.00
WAGD/Evac.....	4601.....	71.50					
1/8" NPT Female 	Oxygen.....	4102.....	\$23.00	DISS Hand Tight 	Oxygen.....	4108.....	\$28.75
	Air.....	4202.....	23.00		Air.....	4208.....	28.75
	Vacuum.....	4302.....	23.00		Vacuum.....	4308.....	28.75
	Nitrous Oxide.....	4402.....	23.00		Nitrous Oxide.....	4408.....	28.75
	WAGD/Evac.....	4602.....	71.50				
1/4" NPT Male 	Oxygen.....	4103.....	\$24.75	1/4" Hose Barb w/ Knob 	Oxygen.....	4111.....	\$29.00
	Air.....	4203.....	24.75		Air.....	4211.....	29.00
	Vacuum.....	4303.....	24.75		Vacuum.....	4311.....	29.00
	Nitrous Oxide.....	4403.....	24.75		Nitrous Oxide.....	4411.....	29.00
	WAGD/Evac.....	4603.....	71.50		WAGD/Evac.....	4611.....	71.50
DISS Male with Knob 	Oxygen.....	4105.....	\$29.50	DISS Male w/ Knob & Check Valve 	Oxygen.....	4114.....	\$33.50
	Air.....	4205.....	29.50		Air.....	4214.....	33.50
	Vacuum.....	4305.....	29.50		Vacuum.....	4314.....	33.50
	Nitrous Oxide.....	4405.....	29.50		Nitrous Oxide.....	4414.....	33.50

QUICK CONNECTS (Female)

CHEMETRON STYLE CHECK UNITS (Female Couplers)

All Pipe Fittings are National Pipe Thread

1/2" NPT Female



Part No. OR 101
O₂ OR 101
Air OR 102

1/2" NPT Male



Part No. OR 104
O₂ OR 101-4
Air OR 102-4

1/4" NPT Male



Part No. OR 101-3
O₂ OR 101-3
Air OR 102-3

1/4" Hose Barb



Part No. OR 101-1
O₂ OR 101-1
Air OR 102-1

DISS Male



Part No. OR 101-2
O₂ OR 101-2
Air OR 102-2

DISS Female

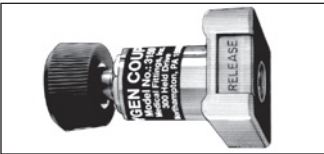

Part No. OR 104-3
O₂ OR 104-3
Air OR 103-3

\$60.00

OHMEDA STYLE CHECK UNITS (Female Couplers)

All Pipe Fittings are National Pipe Thread

1/2" NPT Female



Part No. OR 201
O₂ OR 201
Air OR 202

1/2" NPT Male



Part No. OR 204
O₂ OR 201-4
Air OR 202-4

1/4" NPT Male



Part No. OR 201-3
O₂ OR 201-3
Air OR 202-3

1/4" Hose Barb



Part No. OR 201-1
O₂ OR 201-1
Air OR 202-1

DISS Male



Part No. OR 201-2
O₂ OR 201-2
Air OR 202-2

DISS Female



Part No. OR 204-2
O₂ OR 204-2
Air OR 203-2

\$72.00

PURITAN-BENNETT STYLE CHECK UNITS (Female Couplers)

All Pipe Fittings are National Pipe Thread

1/2" NPT Female



Part No. 4150
O₂ 4150
Air 4250

1/2" NPT Male



Part No. 4151
O₂ 4151
Air 4251

1/4" NPT Male



Part No. 4153
O₂ 4153
Air 4253

1/4" Hose Barb



Part No. 4154
O₂ 4154
Air 4254

DISS Male



Part No. 4155
O₂ 4155
Air 4255

DISS Female



Part No. 4356
O₂ 4356
Air 4358

\$64.00

*Vacuum primary check only

SCHRADER STYLE CHECK UNITS (Female Couplers)

All Pipe Fittings are National Pipe Thread

1/2" NPT Female



Part No. 6150
O₂ 6150
Air 6250

1/2" NPT Male



Part No. 6151
O₂ 6151
Air 6251

1/4" NPT Male

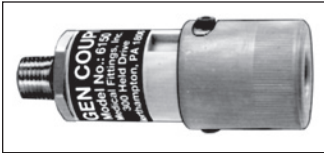

Part No. 6153
O₂ 6153
Air 6253

1/4" Hose Barb



Part No. 6154
O₂ 6154
Air 6254

DISS Male



Part No. 6155
O₂ 6155
Air 6255

DISS Female



Part No. 6356
O₂ 6356
Air 6456

\$90.00

DISS FITTINGS

DISS 90° Elbow Male x Female



Oxygen	Air	Vac	N ₂ O
#0705	#0705-A	#0705-V	#0705-N
\$16.00	\$32.50	\$32.50	\$32.50

DISS Male x NPT Male

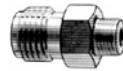

	Oxygen	Air	Vac	N ₂ O
1/8"	#0712...\$5.40	#0731...\$9.00	#0751...\$11.00	#0771...\$14.00
1/4"	#M24-5...\$7.20	#0733...\$9.70	#0753...\$12.60	#0773...\$16.10

DISS Male x DISS Male

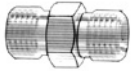

Oxygen	Air	Vac	N ₂ O
#0704	#0704-A	#0704-V	#0704-N
\$7.25	\$28.20	\$28.20	\$28.20

DISS Male x 1/8" NPT Male with Check Valve

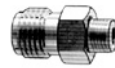

	Oxygen	Air	Vac	N ₂ O
1/8"	#0712...\$13.00	#0742...\$13.40	#0762...\$21.30	#0782...\$22.00
1/4"	#0713...\$13.00	#0743...\$13.40	#0763...\$21.30	#0783...\$22.00

DISS Female x DISS Female



Oxygen	Air	Vac	N ₂ O
#0104	#0104-A	#0104-V	#0104-N
\$17.00	\$29.00	\$29.00	\$29.00

DISS Male x DISS Female



	Oxygen	Air	Vac	N ₂ O
	#1005-SP	#1005-SPA	#1005-SPV	#1005-SPN
	\$34.50	\$34.50	\$34.50	\$34.50

DISS Female x 1/8" NPT Male



Oxygen	Air	Vac	N ₂ O
#0110	#0209	#0309	#0409
\$9.20	\$12.15	\$14.25	\$16.80

DISS Male x 1/8" NPT Female



	Oxygen	Air	Vac	N ₂ O
	#0702	#0702A	#0702V	#0702N
	\$6.00	\$15.50	\$15.50	\$15.50



50 PSI
Auxiliary
Valve

OPTO - \$16.00
(oxygen)

APTO - \$19.00
(AIR)

Thread Comparisons Guide:

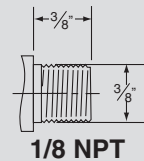
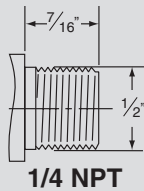

(Measurements given are approximate.)

For Oxequip, Medstar and Schrader quick connects Please Call

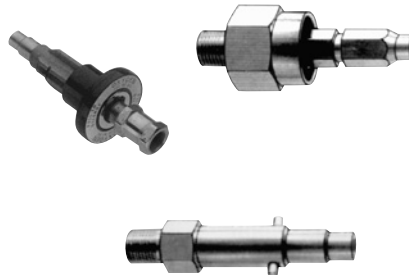

SHUT OFF VALVE



1/4" F x 1/4" F NPT **7045**
1/8" F x 1/8" F NPT **7064**

\$22.00

HAND KNOB x 1/8M x 1/8 F NPT



Oxygen **0162**
Air **0163**
Vacuum **0164**
Nitrous Oxide **0165**

\$6.20

NEB DRIVE RESCUE FLOW

An Economical adapter that delivers a preset flow from standard wall outlets.
It's a convenient, dependable way to administer aerosols.

To order Neb Drive or Rescue Flow with shut off valve, please add an "S" to the end of the part number.
The price is \$40.00 more.

DISS FEMALE



\$24.50

O ₂	6 to 7 LPM	8116
O ₂	7 to 8 LPM	8117
O ₂	8 to 9 LPM	8118
O ₂	10 to 11 LPM	8119
Air	6 to 7 LPM	8216
Air	7 to 8 LPM	8217
Air	8 to 9 LPM	8218
Air	10 to 11 LPM	8219
Rescue Flow	14 to 16 LPM	8115
O ₂	24 to 26 LPM	8114

OHMEDA



\$44.00

O ₂	6 to 7 LPM	8126
O ₂	7 to 8 LPM	8127
O ₂	8 to 9 LPM	8128
O ₂	10 to 11 LPM	8129
Air	6 to 7 LPM	8226
Air	7 to 8 LPM	8227
Air	8 to 9 LPM	8228
Air	10 to 11 LPM	8229
Rescue Flow	14 to 16 LPM	8125
O ₂	24 to 26 LPM	8124

CHEMETRON



\$44.00

O ₂	6 to 7 LPM	8136
O ₂	7 to 8 LPM	8137
O ₂	8 to 9 LPM	8138
O ₂	10 to 11 LPM	8139
Air	6 to 7 LPM	8236
Air	7 to 8 LPM	8237
Air	8 to 9 LPM	8238
Air	10 to 11 LPM	8239
Rescue Flow	14 to 16 LPM	8135
O ₂	24 to 26 LPM	8134

PURITAN-BENNETT

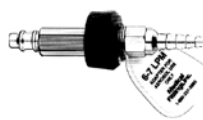

\$29.40

O ₂	6 to 7 LPM	8146
O ₂	7 to 8 LPM	8147
O ₂	8 to 9 LPM	8148
O ₂	10 to 11 LPM	8149
Air	6 to 7 LPM	8246
Air	7 to 8 LPM	8247
Air	8 to 9 LPM	8248
Air	10 to 11 LPM	8249
Rescue Flow	14 to 16 LPM	8145
O ₂	24 to 26 LPM	8144

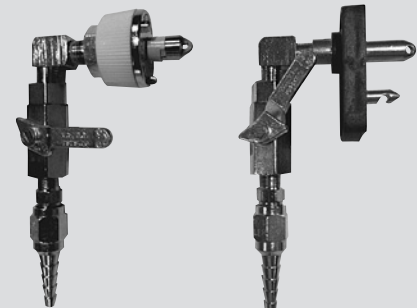

Shut off valve allows you to leave neb drive in wall outlet for as long as you desire.

MISCELLANEOUS

LABELS

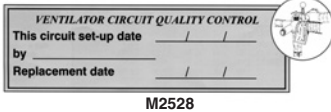

M2528

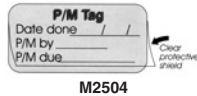

M2504



M2508



M2516

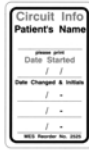

M2525

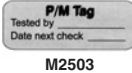

M2503



M2510



M2523



MAGNETIC SIGN
Red and Green
9" x 12"
Part # NS-1
\$34.00
(Minimum order of 10)



M2521

Part #	Labels Per Roll	Price
M2503	150	\$52.00
M2504	150	82.00
M2508	200	37.00
M2510	200	54.50
M2516	150	42.00
M2521	100	62.00
M2523	100	48.00
M2525	150	44.80
M2528	50	38.00

LARGE VOLUME NEBULIZERS



AQUATHERM® External Heater

- Simple, reliable, and durable heater
- Provides aerosol temperatures between 35°C and 38°C*
- Sold individually

Cat No. 048-91 \$474.00

*As measured at the nebulizer elbow @ 8 LPM and full air entrainment. A 9 - 10°C temperature drop will occur at the end of a 1.8 meter hose.



AQUATHERM III® External Adjustable Electronic Heater

- Attaches onto nebulizer system to provide heated aerosol
- Adjustable aerosol temperatures to meet patient needs with a sensitive temperature controller
- Sold individually

Cat No. 050-14 \$876.00



Large Volume Nebulizer

- Disposable nebulizer, designed to deliver humidified gas in concentrations ranging from 28% to 98%
- Lightweight, easy to use
- Bright yellow, Venturi-style entrainment ring with incremental dial for setting oxygen concentrations
- Polypropylene jar holds up to 500cc sterile water
- Clearly marked water levels
- Individually packaged 50 to a case

Cat No. 1770 \$282.00 cs/50

THERMAGUARD® Heater

- For use with Cat. No. 1770
- Provides continuous heated aerosol
- Illuminated power switch and adjustable temperature range with push-to-turn knob
- Sold individually

Cat No. 5705 \$899.00

CANOPIES

Dispos-o-tent is a self supporting croup tent, hood, or aerosol tent. For crib, bed, or incubator. Great for contaminated patient, backup and everyday use. Cuts cost of renting.

Two convenient aerosol ports. heavy-duty metal reinforced and size 24 x 24 x 24 with extra thick reinforcement. Clear plastic. Comes in standard and bottomless.

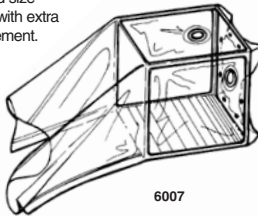

6007

Part #	Size	Qty	Price
M5007	7 x 7 x 7 (bl)	12	\$118.00
M5012	12 x 12x 12 (bl)	6	88.00
M6007	7 x 7 x 7	12	118.00
M6012	12 x 12x 12	6	88.00
M6018	18 x 18 x 18	5	110.50
M6024	24 x 24 x 24	6	167.60

(bl) = Bottomless

Canopies for:

Part #	Description	Cases of 6
M0236	Ohio Pediatric Aerosol	\$97.00
M0279	Mistogen CAM III	\$78.50
M0291	DeMistifier® Std.	\$78.50

*DeMistifier is a trademark of Peace medical, Inc.

LO₂ PRESSURE GAUGE (Low Pressure Alarm)



Audible and Visible Alarm When Tank Pressure Falls Below 500 PSI

The LO₂ is a Standard Pressure Gauge up to 4000 PSI for use on any tank where low pressure is a hazard or an inconvenience. For use on standard regulators - 1/4" or 1/8" inch fittings. Buzzer, Flashing Red Light, On/Off Switch and Battery Test Button helps you ensure that you are never caught off-guard.

Part #	Description	Price
S2000-1/4	1/4" Thread	\$276.00
S2000-1/8	1/8" Thread	\$276.00

TEST GAUGE OXYGEN



For testing cylinder contents
3000 psi Max.

Oxygen CGA-540
RH Female Handtight Nut

MGT-540.....\$79.00

INSPIRATORY MUSCLE TRAINER

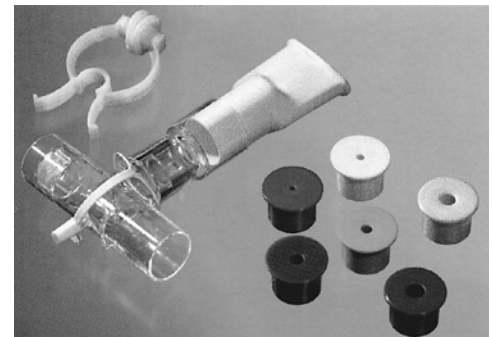

Inspiratory Muscle Trainer

Designed to strengthen respiratory muscles, the Trainer features six color-coded resistors for selecting the appropriate inspiratory resistance level; a port for monitoring or oxygen delivery; nose clips; and 15mm internal diameter for direct application to the endotracheal airway.

Part #22-7500.....\$225.00/case of 10

MISCELLANEOUS

RUSCH POSITIVE - NEGATIVE PRESSURE GAUGE

60 - 0 - 60 mm. hg.

- Measures: • Millimeters of Mercury
• Centimeters of Water

395943	Gauge only	\$85.00
395943 P	Gauge with Gage-Gard	127.00
2800	Gage-Gard only	44.00
33-3505	Tubing, T piece, Trach fitting	6.00 each or \$171.00/case of 48



Hose Barb Fitting

POSEY CUFFLATOR™

ENDOTRACHEAL TUBE INFLATOR & MANOMETER

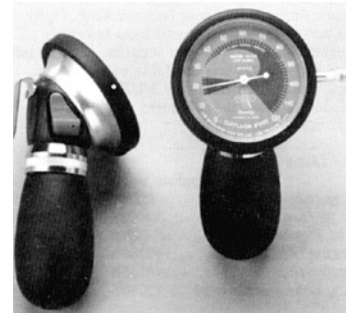

An accurate, convenient tracheal cuff inflator and manometer. No more syringes, electricity or complicated connections needed to check cuff pressure regularly. Air vent button and inflator bulb let you vary cuff pressure quickly and easily. Clip on back allows easy positioning. Gauge shows recommended pressure range in cm H₂O.

#8199 Cufflator with instrument case..... \$469.00

ANESTHESIA ASSOCIATES PRESSURE MANOMETER

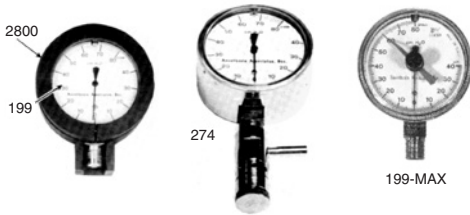

Manometer has range of -40 to +80 cm H₂O in a 2 1/2" diameter chrome plated case with 1/4" NPT bottom connection. Has front zero correcting screw.

MAX is a resettable low friction pointer to capture maximum pressure or vacuum reading

Part#	Description	Price
199	Gauge with 1/4" NPT	\$91.00
199 P	above gauge with Gage-Gard	119.00
274	Gauge with 5-55 cm H ₂ O adjustable pressure relief valve and "T" for supply tubing.	152.00
274 P	above gauge with Gage-Gard	180.00
2800	Gage-Gard only (1/4" rubber protector)	44.00

Part#	Description	Price
199-MAX	Gauge with Pointer	139.00
199P-MAX	above gauge with Gage-Gard	167.00
274-MAX	274 with Pointer	179.00
274P-MAX	above gauge with Gage-Gard	207.00

ARTERIAL BLOOD GAS KITS

Pulset cricket system with needle, 25U balance heparin. Alcohol pad, iodophor preps, 2 x 2 gauze, ice bag, bandage and patient ID.



Part #	Description	Case Quantity	Price
336295	Kit 22G x 1" N	100	490.00
336395	Kit 23G x 1" N	100	432.00

Respironics Millenium 5 lpm Concentrator



lightest, quietest, most durable concentrator on the market today

Part Number: RMC-01 \$1295.00

OXYGEN TIMER



TIMOX features:

- Automatic timing of oxygen flow as low as .30 lpm.
- Unit easily reset to zero with tip of pen or pencil.
- 1999.9 recorded hours of oxygen flow.
- Two year warranty on unit excluding battery.

Timer.....Part #8050 \$132.50
Replacement BatteryPart #8066 \$17.50

INDUSTRIAL STRENGTH FASTENER HOLDS FIRM YET ALLOWS FOR EASY SEPARATION

Prevent equipment from falling with the self adhesive Zip Grip. Ideal for securing monitors on top of ventilators. Prevents equipment from sliding in transport. Snaps together. Snaps apart. Sticks to any surface. 1" wide.

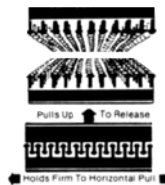

#3710..... \$14.75/foot

#2200 Flexible Connector (Silicone Rubber)

22mm I.D. x 22mm I.D.

This adapter was designed almost identical to the ones listed below.

INTEC 2200 • BENNETT 3443 • MARQUEST 172200
AM SYSTEMS 1139 • Instrumentation Ind. 101-00-3443

\$217.00 per case of 50 / \$6.30 each

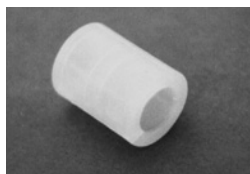

LITERMETER

Every therapist should have one for checking the accuracy of regulators and flowmeters.



- 0-2.5 lpm model in 1/4 liter increments
- 0-8 lpm model in 1/2 liter increments
- individually calibrated
- pocket clip reduces loss
- large, easy to read numbers
- calibrated at the delivery pressure to the patient (approximately atmospheric pressure)
- well-designed nipple reduces leakage
- accuracy ± 5% of full scale for 0-8 LPM (± .4 LPM)
- accuracy ± 10% of full scale for 0-2 LPM (± .25 LPM)

Part #	LPM	Price
MT100	0-2.5	\$37.00
MT200	0-8	37.00
MT300	2-15	37.00

WESTERN MEDICA

MISCELLANEOUS PLASTIC BAGS, EQUIPMENT COVERS

LEMANS INDUSTRIES



GAS STERILIZATION

Super heavy duty, mint green, use for ethylene-oxide sterilization.

Part No.	Description	Quantity	Price
MSF-1	3½ x 6	2000	\$97.00
MSF-2	7 x 14	1000	\$97.00
MSF-3	9 x 18	700	\$97.00
MSF-4	12 x 15	600	\$97.00
MSF-5	15 x 24	300	\$97.00
MSF-6	20 x 30	200	\$97.00



PATIENT SET-UP (Cotton Drawstring)

Part No.	Description	Quantity	Price
0049	8 x 10	500	\$109.00
0059	11 3/4 x 15	500	\$116.20
XL-S2	16 x 18 x 3	250	\$111.50



RESUSCITATION

Heavy duty drawstring bag. Use in ambulances, ICU, crash carts and in ER. Hold resuscitation bag, airways, etc.

Part No.	Description	Quantity	Price
ERE-1	17 x 21	250	\$120.20

EQUIPMENT COVERS

Dust covers designed to protect ventilators and other equipment. Comes on a roll. Clear.

Part No.	Description	Quantity	Price
CC-1	38 x 26 x 48 (Hospital cart, incubators)	50	\$95.50
MC-3	12 x 8 x 26 (Nebulizers, IV pumps)	250	\$101.10
PLC-38	16 x 14 x 38 (Portable suction machine)	165	\$80.00
PLC-60	28 x 22 x 56 (Large ventilators)	55	\$105.00
MC-5	28 x 22 x 35 (Wheel chairs, commodes, concentrators, walkers, Puritan-Bennett 7200)	150	\$135.70
ID-30	Roll Dispenser for PLC-60 and MC-5	1	\$72.00



BAGS ON A ROLL

Part No.	Description	Quantity	Price
S-6528	8 x 12	1000	\$132.00
S-3032	10 x 12	1000	\$171.00

RESEALABLE BAGS (Not on a roll)

Part No.	Description	Quantity	Price
S-1700	8 x 12	1000	\$128.00
S-1298	8 x 10	1000	\$168.00
S-1301	12 x 15	1000	\$267.00

VOLDYNE® INCENTIVE SPIROMETER



Voldyne volumetric exerciser features Good - Better - Best flow window in a compact, ergonomic design with advanced, low work-of-breathing filter design and built in handle.

Part #	Description	Price (12 per case)
8884719009	5000 ml	\$126.00
8884719025	2500 ml	126.00
8884719017	Pediatric (colorful)	147.00

MDI ADAPTER



- No. 1659 \$164.00**
- Standard 22 mm I.D./O.D. connections for placement in-line
 - Tee adapter with arrow allows therapist to direct aerosolized medication toward patient or away for "reservoir" effect
 - Fits most standard canisters
 - Individually packaged 50 to a case

DISPOSABLE MANUAL RESUSCITATORS

HUDSON - RCI

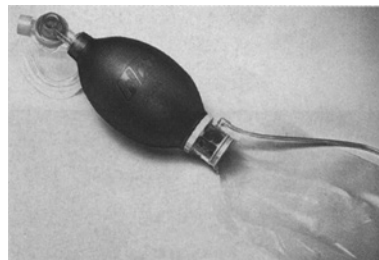

Lifesaver® Manual Resuscitator

Disposable resuscitator meets ISO and ASTM standards. Features low-resistance non-rebreathing valve and right-angle oxygen tubing connector that swivels 360°. Easy to assemble. Mask included.

Adult Size	HU5370	\$ 181.50	cs/6
Child Size	HU5365	235.50	cs/6
Neonate Size	HU5360	229.50	cs/6
Adult Resuscitator with Flow Diverter and Mask	HU5372	191.25	cs/6

BLENDERS - Precision Medical

Air/O₂



Its unique. It is the only unit available that allows the clinician to turn the bleed control to ON or OFF providing quieter operation. This feature is especially useful in the NICU and PICU.

Part #	Flow	Rate	Price
5200	High Flow	15 - 120 lpm	999.00
5300	Low Flow	3 - 30 lpm	999.00

Heliox



Its unique. It is the only free-standing pneumatic HeliO₂ blending device on the market today. The ability to turn the bleed control collar ON or OFF provides ± 3% F_{IO2} accuracy as well as quieter operation and maximal Heliox tank durations.

Part #	Flow	%	Price
5570	High Flow	70 - 30	1795.00
5580	High Flow	80 - 20	1795.00
5470	Low Flow	70 - 30	1795.00
5480	Low Flow	80 - 20	1795.00

MISCELLANEOUS

FILTERS

Pulmonary Function Filters



CBI-1501
1 1/8"



CBI-1502
1 1/4"



CBI-1503
1 3/4"

The Clear Advantage

- Bacterial Removal Efficiency (BRE): 99.99%
- Viral removal efficiency (VRE): 99.90%
- Dead Space: 54mL (Low dead space is critical for use in advanced pulmonary mechanics and diffusion testing)
- Flow Resistance: .40 cm-H₂O/L/Sec. (@ 12 L/Sec.) (3X more efficient than ATS specification)
- Flow Resistance: .16 cm-H₂O/L/Sec. (Avg. 0 -12 L/Sec.)
- Low resistance assures compliance with ATS standards (even when saturated with water vapor)
- Built-in cardboard mouth pieces for patient comfort
- Angled input port allows the cardboard mouthpiece to be removed and replaced with a rubber "Bite Adaptor" for use in Pulmonary Diffusion Tests
- Utilizes a revolutionary "Drum" design to hold electrostatic filter media in place
- No "pins" or "fins" to obstruct flow
- Each disposable filter is individually wrapped and sealed

Part #	Fits	Price
CBI-1501	Creative Biomedics (above) MultiSPIRO	\$209/Box of 100
CBI-1502	Sensor Medics	\$209/Box of 100
CBI-1503	Koko, Spirometrics	\$209/Box of 100

Multi-O² Manifold

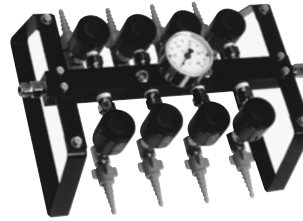

Part Number
MDM-8

\$1195.00

- Used for mass casualty, EMS, and triage situations
- Oxygen delivery for up to 8 patients
- Flowmeters are individually controlled
- 8 easy-to-read click style flowmeters from 0-25 lpm
- Standard DISS 1240 inlet and 100 psi relief valve safety feature
- Cannulas, breathing masks, and compact carrying case included

MODULOSE™ UNIT DOSE SALINE



Unit dose saline is offered in convenient packaging with easy open twist and pull. Contains no preservatives, 0.9% Sodium Chloride

PH5251	3 ml. vial	100/box \$39.70
PH5257	5 ml. vial	100/box \$42.80
PH5262	15 ml. vial	144/box \$99.00

MATCH MATES® BLOOD PRESSURE COMBINATION KIT with Fanny Pack



- Ideal for nurses, EMT's and students
- Includes Sprague Rappaport-Type stethoscope
- Matching oversized fanny pack

Part #	Color	Price
01-365-021	Black	\$98.00



Air Gun

Air Gun with 20' Coil Hose
Diss Female Air inlet

Part # 1921
\$147.00

2800 Gage-Gard.....\$44.00



Designed for most bottom port pressure gauges i.e: OEM, DHD, Portex, Instrumentation Industries, Boehringer, Anesthesia Associates, and many others.
Fits 2 1/2" gauges.

ALUMINUM CYLINDERS (EMPTY)



Medilux® Aluminum Cylinder Features:

- Aluminum cylinders are 40% lighter than steel
- Cylinders are cleaned for medical oxygen service
- Safety paint protects cylinder side walls and provides heat detection
- Cylinder finish is easy to clean and maintain
- Straight thread design eliminates thread damage and provides positive seal

Toggle Valve

PART #	CYLINDER	PRICE
PX-8701-1T	C (246 Liters)	91.00
PX-8702-1T	D (425 Liters)	98.00
PX-8703-1T	E (679 Liters)	104.50

LIFESAVER® ISOLATION VALVE



Lifesaver Isolation Valve prevents mouth-to-mouth contact during resuscitation. Used with mask and mouthpiece, it directs exhalation away from rescuer. Disposable.

Lifesaver Filtered Isolation Valve Kit with

Lifesaver Filtered Valve, mouthpiece and disposable resuscitation mask. Adult.

HU1184.....each \$18.00

MISCELLANEOUS



(7-5A)



(0159C)

Nut and Nipple (Christmas Tree)

Part #	Description	Price
7-4A	One piece Green	\$27.00 cs/50
0159	Metal	\$ 6.80 each
0159C	Metal w/ 6" chain	\$ 7.90 each
7-5A	Two piece Green	\$34.00 cs/50
7-5C	Two piece Yellow	\$46.00 cs/50
7-5D	Two piece White	\$43.70 cs/50
7-5E	Two piece Blue	\$43.70 cs/50
7-5G	Two piece Black	\$43.70 cs/50
7-5H	Two piece Clear	\$46.00 cs/50

Yoke Washer



2544-2



2540-W

Part #	Description	Price
2540-W	nylon	\$23.00 cs/50
2544-2	aluminum w/ rubber center	\$ 2.30 each
2544-2C	aluminum w/ rubber center	\$98.00 cs/50

Small Cylinder Plastic Hand Wheel



#66071 . \$65.05 / case of 10

Plastic Small Cylinder Wrench



7-92A Black 7-92B.. Green
7-92C White 7-92D Pink

\$26.00 / case of 10

Metal Wrench (For Small & Large Cylinders)



#WR-3..... \$11.70 ea.

Metal Large Cylinder Wrench



#66082..... \$8.20 ea.

Metal Small Cylinder Wrench



Part #	Description	Price
MCW-2B	Wrench	36.00 cs/10
MCW-2BC	Wrench w/chain	44.60 cs/10

YOKES (1/4" NPT) with "T" handle



Part #	Gas	Price
M87-4	Oxygen	27.00
M87-4S	Oxygen (swivel)	28.50
M95-4	Air	32.00
M94-4	Carbon Dioxide	32.00
M91-4	Nitrous Oxide	32.00
M960-4	Nitrogen	32.00
M003	"T" handle only	6.75

Cylinder Connections (Inlet)



(Large Cylinders)
1/4" NPT

Gas	CGA #	Part #	Price
Oxygen	540	1192	16.50
Air	346	7504	19.50
Nitrous Oxide	326	7506	20.70
Carbon Dioxide	320	7501	19.50
Mixture	280	7503	19.50
Helium & Nitrogen	580	7507	20.70
Mixture	500	7505	19.50



Hudson 5080..... \$7.90 each

REPLACEMENT GAUGES FOR OXYGEN REGULATORS

POSEY CUFFLATOR™

1 1/2" BOTTOM Port

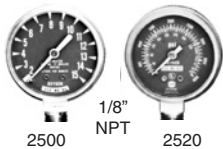

Part #	Description	Price	With Protector	Price
2500	15 lpm	\$ 24.50	2500P	\$31.50
2520	contents (0-4000 psi)	\$ 24.50	2520P	31.50
2539	8 lpm	\$ 24.50	2539P	31.50
2545	5 lpm	\$ 29.10	2545P	36.10
2542	100 psi	\$ 24.50	2542P	31.50
2536	lens cover (twist on)	\$ 1.75		
2536S	lens cover (snap in)	\$ 1.75		

ENDOTRACHEAL TUBE INFLATOR & MANOMETER



An accurate, convenient tracheal cuff inflator and manometer. No more syringes, electricity or complicated connections needed to check cuff pressure regularly. Air vent button and inflator bulb let you vary cuff pressure quickly and easily. Clip on back allows easy positioning. Gauge shows recommended pressure range in cm H₂O.

#8199 Cufflator with instrument case \$469.00

1 1/2" BACK Port

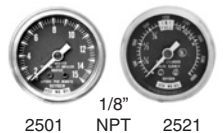

Part #	Description	Price	With Protector	Price
2501	15 lpm	\$ 24.50	2501P	\$31.50
2521	contents (0-4000 psi)	\$ 31.70	2521P	38.70
2540G	8 lpm	\$ 24.50	2540GP	31.50
2544	5 lpm	\$ 29.10	2544P	36.10
2536	lens cover (twist on)	\$ 1.75		
2536S	lens cover (snap in)	\$ 1.75		

2" BOTTOM Port

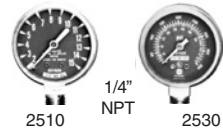

Part #	Description	Price	With Protector	Price
2510	15 lpm	\$ 24.50	2510P	\$31.50
2530	contents (0-4000 psi)	\$ 24.50	2530P	31.50
2541	8 lpm	\$ 24.50	2541P	31.50
2546	5 lpm	\$ 29.10	2546P	36.10
2543	100 psi	\$ 24.50	2543P	31.50
2537	lens cover (twist on)	\$ 1.75		

All gauges come with lens cover.



Air, CO₂ Replacement Gauges:
2" 0-100 psi #MG-C11..... \$33.00
2" 0-4000 psi #MG-C9..... \$33.00

Teflon Thread Tape
1/4" x 520" Roll
MTT-1 \$ 2.50



Low Profile 3000 psi Gauge with protector
MJ-C1 \$15.00
MJ-C1P..... \$19.50

RC Medical, Inc.
 284 Merrow Drive
 P.O. Box 833
 Tolland, CT 06084

Please deliver this catalog to the Purchasing
 Department if addressee is not available

PRSRST STD
 U.S. Postage
PAID
 Hartford, CT
 Permit No. 2202

**ALLIED ALL BRASS OXYGEN
 REGULATOR**

0, .5, 1, 1.5, 2, 3, 4, 5, 6, 8, 10, 15 settings



Nipple outlet not for
 use with humidifier.

Order #21017.....\$109.00
 for small cylinder (870)

**Chemetron 0-15 lpm H Cylinder
 Oxygen Regulator**



Part # OS-27.....\$99.00
 Only Thirty Units Available

Adjustable
 height
 small cylin-
 der cart for
 "D" and "E"
 cylinders.



#SPX-1060.....\$17.00

BACTERIAL / VIRAL FILTERS

Main Flow Bacterial / Viral Filter

- 22mm ID x 15mm ID/22mm OD
- Bacterial filtration efficiency 99.999+%
- Viral filtration efficiency 99.99+%
- Dead space: 42mL
- Flow resistance: approximately 1.5 cmH₂O at 60 LPM
- Individually packaged 50 to a case



1605

Catalog # 1605
 Price.....\$193.00

**TRI-BLOCK
 ASSEMBLIES**

Ohmeda Style



OR301-77-3	O ₂	256.20
OR302-77-3	Air	256.20
OR304-77-3	Vac	256.20
OR303-77-3	N ₂ O	256.20

Chemetron Style



OR301-76-3	O ₂	239.00
OR302-76-3	Air	239.00
OR304-76-3	Vac	239.00
OR303-76-3	N ₂ O	239.00

100% Satisfaction Guarantee

If a product you order does not meet your specifications, we will be happy to assist you in its return up to 30 days from purchase date.

Please obtain a RGA# from us prior to returning items.

After 30 days, a 20% restocking charge will be assessed for items ordered in error. Products returned must be in its original packaging.

After 90 days, products may not be returned.

**HEALTHCARE INSTITUTIONS HAVE
 AN OPEN 30 DAY ACCOUNT**

NO MINIMUM ORDER - PURCHASE ORDERS ACCEPTED

F.O.B. Origin. Prices subject to change without notice.

**Toll Free Phone
 888-431-2727
 1-860-871-4156**

**Toll Free Fax
 888-337-0443
 1-860-870-0443**



ALL IN STOCK ORDERS PLACED BY 2 PM (EST) SHIPPED THE SAME DAY.